

TECHNICAL CATALOGUE

HITACHI

Cooling & Heating



MULTIZONE

OUTDOOR UNIT
RAM-S18U2HLAE

INDOOR
RAS-EH07QHLAE
RAS-EH(09-12)RHLAE
RAS-SH07QHLAE
RAS-SH(09-12)RHLAE
RAD-SH(07-12)QHLAE
RAI-SH(07-12)QHLAE
RAF-SH(07-12)QHLAE

HITACHI

Specifications in this catalogue are subject to change without prior notice in order for HITACHI to bring in the latest innovations to their customers

Whilst every effort is made to ensure that all dimensions and specifications are correct, any printers' error not rectified are outside the control of HITACHI, who cannot be held responsible for the same

CONTENTS

CONTENTS	1
1 SPECIFICATIONS	1-1
1.1. MULTIZONE INDOOR	1-2
1.1.1. WALL TYPE (RAS-EH07QHLAE, RAS-EH09/12RHLAE)	1-2
1.1.2. WALL TYPE (RAS-SH07QHLAE, RAS-SH09/12RHLAE)	1-3
1.1.3. FLOOR TYPE (RAF-SH07/09/12QHLAE)	1-4
1.1.4. CEILING CASSETTE (RAI-SH07/09QHLAE)	1-5
1.1.5. CEILING CASSETTE (RAI-SH12QHLAE)	1-6
1.1.6. DUCT TYPE (RAD-SH07/09/12QHLAE)	1-7
1.1.7. DUCT STATIC PRESSURE AND AIR FLOW (RAD-SH07/09/12QHLAE)	1-8
1.2. MULTIZONE OUTDOOR (RAM-S18U2HLAE)	1-9
2 DIMENSIONAL DATA	2-1
2.1. MULTIZONE INDOOR UNITS	2-2
2.1.1. WALL TYPE (RAS-EH07QHLAE, RAS-EH09/12RHLAE)	2-2
2.1.2. WALL TYPE (RAS-SH07QHLAE, RAS-SH09/12RHLAE)	2-3
2.1.3. FLOOR TYPE (RAF-SH07/09/12QHLAE)	2-4
2.1.4. CEILING CASSETTE (RAI-SH07/09/12QHLAE)	2-5
2.1.5. DUCT TYPE (RAD-SH07/09/12QHLAE)	2-6
2.2. MULTIZONE OUTDOOR UNITS (RAM-S18U2HLAE)	2-7
3 CAPACITIES AND SELECTION DATA	3-1
3.1. SYSTEM SELECTION PROCEDURE	3-2
3.1.1. SELECTION UNIT FEATURES	3-2
3.1.2. SELECTION GUIDE	3-2
3.2. CAPACITY CHARACTERISTIC CURVES FOR MULTIZONE	3-3
3.3. CORRECTION FACTORS ACCORDING TO PIPING LENGTH	3-8
3.4. CORRECTION FACTORS ACCORDING TO DEFROSTING OPERATION	3-10
3.5. COMBINATION TABLE FOR MULTIZONE OUTDOOR	3-11
4 SOUND DATA	4-1
4.1. SOUND DATA (RAM-S18U2HLAE)	4-2
5 WORKING RANGE	5-1
5.1. POWER SUPPLY	5-2
5.2. WORKING RANGE	5-2
5.2.1. MULTIZONE	5-2
6 ELECTRICAL DATA	6-1
6.1. INDOOR UNIT	6-2
6.2. OUTDOOR UNIT	6-3
7 WIRING DIAGRAM	7-1
7.1. MULTIZONE	7-2
7.1.1. RAS-EH07QHLAE, RAS-EH09/12RHLAE	7-2
7.1.2. RAS-SH07QHLAE, RAS-SH09/12RHLAE	7-3
7.1.3. RAF-SH07/09/12QHLAE	7-4
7.1.4. RAI-SH07/09/12QHLAE	7-5
7.1.5. RAD-SH07/09/12QHLAE	7-6
7.2. RAM-S18U2HLAE	7-7

8	REFRIGERANT CYCLE	8-1
8.1.	MULTIZONE INDOOR UNITS	8-2
8.1.1.	WALL TYPE (RAS-EH07QHLAE, RAS-EH09/12RHLAE)	8-2
8.1.2.	WALL TYPE (RAS-SH07QHLAE, RAS-SH09/12RHLAE)	8-3
8.1.3.	FLOOR TYPE (RAF-SH07/09/12QHLAE)	8-4
8.1.4.	CEILING CASSETTE (RAI- SH07/09/12QHLAE)	8-5
8.1.5.	DUCT TYPE (RAD-SH07/09/12QHLAE)	8-6
8.2.	MULTIZONE OUTDOOR UNITS (RAM-S18U2HLAE)	8-7
9	CONTROL AND FUNCTION	9-1
9.1.	WIRELESS REMOTE CONTROL FUNCTION	9-2
9.1.1.	RAR-M0B3, RAR-M0B4, RAR-M0B5 AND RAR-M0B6	9-2
9.2.	SHIFT VALUE	9-3
9.3.	OPERATION LOCK	9-5
9.4.	SETTING THE PREVENTION OF MUTUAL INTERFERENCE	9-6
9.5.	INTERMITTENT FAN SPEED SETTING	9-6
9.6.	FAN SPEED SETTING IN THERMO OFF IN COOLING	9-7
9.7.	ERROR CODE INFORMATION	9-8
9.8.	ADDITIONAL FUNCTION VIA DIP-SWITCH SETTINGS	9-10
9.8.1.	AUTO RESTART FUNCTION	9-10
9.8.2.	HEATING/COOLING ONLY MODE SELECTION	9-10
9.9.	WIRELESS REMOTE CONTROL FUNCTION	9-11
9.10.	SHIFT VALUE	9-13
9.11.	DISPLAY OPERATION MODE SETTING	9-14
9.12.	HOW TO CHANGE THE INTERMITTENT FAN CONTROL SETTING	9-15
9.13.	HOW TO CHANGE THE FAN SPEED IN COOLING MODE DURING THERMO OFF	9-16
9.14.	SETTING THE PREVENTION OF MUTUAL INTERFERENCE	9-17
10	OPTION LIST	10-1
10.1.	WIRED REMOTE CONTROL SPX-RCDA1 AND SPX-RCDB1	10-2
10.1.1.	SHIFT VALUE	10-3
10.1.2.	ERROR CODE INFORMATION	10-4
10.2.	WIRED REMOTE CONTROL SPX-WKT4	10-7
10.2.1.	SERVICE MENU OPERATION	10-8
10.2.1.1.	SERVICE MENU	10-8
10.2.1.2.	DISPLAY ROOM TEMPERATURE	10-9
10.2.1.3.	CONTACT INFORMATION REGISTRATION	10-9
10.2.1.4.	LIMIT OPERATION	10-10
10.2.1.5.	SHIFT CHANGE	10-11
10.2.1.6.	INTERMITTENT FAN CONTROL	10-12
10.2.1.7.	FAN SPEED DURING THERMO OFF	10-13
10.2.1.8.	OPERATION LOCK	10-14
10.2.1.9.	DISPLAY MALFUNCTION	10-15
10.2.1.10.	DISPLAY ALARM HISTORY	10-16
10.2.1.11.	DEFROSTING INHIBIT PERIOD SELECTION	10-17
10.2.1.12.	ECO AUTO OFF	10-18
10.2.1.13.	CLEAN (SERVICE)	10-19
10.2.1.14.	KEY LOCK	10-19
10.2.2.	CHECK MENU OPERATION	10-20
10.2.2.1.	SELF CHECKING	10-20

10.3.	H-LINK ADAPTOR – PSC 6RAD _____	10-23
10.3.1.	SAFETY SUMMARY _____	10-23
10.3.2.	INSTALLATION WORK _____	10-23
10.3.3.	ELECTRICAL WIRING _____	10-24
10.3.4.	DIP SWITCH SETTING _____	10-25
10.3.5.	TEST RUN _____	10-26
10.4.	DRY CONTACT (SPX-WDC2 AND SPX-WDC3) APPLICATION (USING DIP SWITCH) _____	10-27
10.5.	DISTRIBUTOR – SPX-DST1 _____	10-30
10.6.	REMOTE SENSOR - SPX-RTH1 _____	10-31
10.6.1.	SELECTION OF INSTALLATION POSITION _____	10-31
10.6.2.	INSTALLATION PROCEDURE _____	10-31
10.6.3.	WIRING PROCEDURES _____	10-31

1 SPECIFICATIONS

CONTENTS

1	SPECIFICATIONS	1-1
1.1.	MULTIZONE INDOOR	1-2
1.1.1.	WALL TYPE (RAS-EH07QHLAE, RAS-EH09/12RHLAE)	1-2
1.1.2.	WALL TYPE (RAS-SH07QHLAE, RAS-SH09/12RHLAE)	1-3
1.1.3.	FLOOR TYPE (RAF-SH07/09/12QHLAE)	1-4
1.1.4.	CEILING CASSETTE (RAI-SH07/09QHLAE)	1-5
1.1.5.	CEILING CASSETTE (RAI- SH12QHLAE)	1-6
1.1.6.	DUCT TYPE (RAD-SH07/09/12QHLAE)	1-7
1.1.7.	DUCT STATIC PRESSURE AND AIR FLOW (RAD-SH07/09/12QHLAE)	1-8
1.2.	MULTIZONE OUTDOOR (RAM-S18U2HLAE)	1-9

1.1. MULTIZONE INDOOR**1.1.1. WALL TYPE (RAS-EH07QHLAE / EH09RHLAE / EH12RHLAE)**

INDOOR	Unit	RAS-EH07QHLAE	RAS-EH09RHLAE	RAS-EH12RHLAE
Nominal capacity adjustable		no	no	no
Nominal Cooling capacity (min - max)	BTU	7000(3050-9000)	9000(5450~10500)	12000(5500~13200)
Cooling sensible capacity	BTU	-	-	-
Nominal Heating capacity (min - max)	BTU	9000(3050-10900)	10500(4200~11500)	13000(4400~14500)
Noise level cooling (sound pressure) (SL / L / M / H)	dB(A)	29/36/40/42	29/36/40/42	29/36/40/44
Noise level heating (sound pressure) (SL / L / M / H)	dB(A)	29/36/40/42	29/36/40/42	29/36/40/44
Noise level (sound power) *match with Fiche/ Eurovent/Product Info	dB(A)	56	56	58
Air flow cooling mode (SL / L / M / H)	cfm (m ³ /h)	170/218/250/290	170/218/250/290	170/218/250/320
Air flow heating mode (SL / L / M / H)	cfm (m ³ /h)	170/218/250/290	170/218/250/290	170/218/250/320
Fan Motor	W	38	38	38
Dehumidification	l/h	1.0	1.4	1.6
Included drain pump *for RAI/RAD	yes/no	no	no	no
Max. height available for drain pump (RAD/RAI only)	in. (mm)	no	no	no
Drain pump pressure lift *for RAI/RAD	in. (mm)	no	no	no
Static pressure switch at High(L / M / H) *for RAD	Pa (m3/h)	no	no	no
Dimensions (H x W x D)	in. (mm)	11.07x30.70x9.05 (280x780x230)	11.07x30.70x9.05 (280x780x230)	11.07x30.70x9.05 (280x780x230)
Weight *must match with Packing data information	lbs. (kg)	20.9 (9.5)	20.9 (9.5)	20.9 (9.5)
Panel weight *for RAI	lbs. (kg)	-	-	-
Panel dimensions (H x W x D) *for RAI	in. (mm)	-	-	-
Colour (Munsell Code)				
Condensate Drain	in. (mm)	-	-	-
Panel reference		-	-	-
Color of the panel (RAL)		-	-	-
Running current (C/H) *for single split indoor&outdoor must be matched	A	-	-	-
Power supply	V	FROM OUTDOOR	FROM OUTDOOR	FROM OUTDOOR
Cable section (interconnection/*if power supply is connected to indoor)	mm ²	0.8x 3+EARTH/-	0.8x 3+EARTH/-	0.8x 3+EARTH/-
Piping diameter (Liq / Gas)	Inch	1/4" / 3/8"	1/4" / 3/8"	1/4" / 3/8"
Drain diameter (ext)	in. (mm)	0.63(16)	0.63(16)	0.63(16)
Remote control (standard/optional) *	Standard	RAR-MOB5	RAR-MOB5	RAR-MOB5
	Optional	SPX-RCDB1/SPX-WKT4	SPX-RCDB1/SPX-WKT4	SPX-RCDB1/SPX-WKT4
Filter				
ACL Filter Standard (Material & Accessory code)		activated carbon / SPX-CFH22AC25	activated carbon / SPX-CFH22AC25	activated carbon / SPX-CFH22AC25
ACL Filter Standard Dimensions (H x W x D)	in. (mm)	48x243x5	48x243x5	48x243x5
ACL Filter Optional (Material - Accessory code)		-	-	-
Pre-filter Standard Material		STAINLESS	STAINLESS	STAINLESS
Pre-filter Optional (Material & Accessory code)		-	-	-

NOTE:

1. Capacity and seasonal performance data (SEER /HSPF) are based on AHRI 210-240. The nominal heating and cooling capacity is the combined capacity of the HITACHI Split system (Indoor + Outdoor Unit).

Operation Conditions		Cooling	Heating
Indoor Air Inlet Temperature	dB	80 °F	70 °F
	WB	67 °F	
Outdoor Air Inlet Temperature	dB	95 °F	47 °F
	WB		43 °F

Piping Length: 7.5 meters; Piping Lift: 0 meter
dB: Dry Bulb; WB: Wet Bulb

2. The Sound Pressure Level is based on the following conditions:

- 0.8 meter beneath indoor height center
- 1 meter from Discharge grille

The above data was measured in an anechoic chamber so that reflected sound should be taken into consideration when installing the unit.

1.1.2. WALL TYPE (RAS-SH07QHLAE / SH09RHLAE / SH12RHLAE)

INDOOR	Unit	RAS-SH07QHLAE	RAS-SH09RHLAE	RAS-SH12RHLAE
Nominal capacity adjustable		no	no	no
Nominal Cooling capacity (min - max)	BTU	7000(3050-9000)	9000(5100~10500)	12000(5150~14000)
Cooling sensible capacity	BTU	-	-	-
Nominal Heating capacity (min - max)	BTU	9000(3050-10900)	11000(5450~15000)	14000(5500~18000)
Noise level cooling (sound pressure) (SL / L / M / H)	dB(A)	27/35/40/43	27/35/40/43	27/35/40/46
Noise level heating (sound pressure) (SL / L / M / H)	dB(A)	27/35/40/43	27/35/40/43	27/35/40/46
Noise level (sound power) *match with Fiche/ Eurovent/Product Info	dB(A)	57	57	60
Air flow cooling mode (SL / L / M / H)	cfm (m³/h)	150/200/280/320	150/200/280/320	150/200/280/400
Air flow heating mode (SL / L / M / H)	cfm (m³/h)	180/230/310/330	180/230/310/330	180/230/310/400
Fan Motor	W	30	30	30
Dehumidification	l/h	1.0	1.0	1.5
Included drain pump *for RAI/RAD	yes/no	no	no	no
Max. height available for drain pump (RAD/RAI only)	in. (mm)	no	no	no
Drain pump pressure lift *for RAI/RAD	in. (mm)	no	no	no
Static pressure switch at High(L / M / H) *for RAD	Pa (m3/h)	no	no	no
Dimensions (H x W x D)	in. (mm)	11.81x35.43x9.05 (300x900x230)	11.81x35.43x9.05 (300x900x230)	11.81x35.43x9.05 (300x900x230)
Weight *must match with Packing data information	lbs. (kg)	28.7 (13)	28.7 (13)	28.7 (13)
Panel weight *for RAI	lbs. (kg)	-	-	-
Panel dimensions (H x W x D) *for RAI	in. (mm)	-	-	-
Colour (Munsell Code)				
Condensate Drain	in. (mm)	-	-	-
Panel reference		-	-	-
Color of the panel (RAL)		-	-	-
Running current (C/H) *for single split indoor&outdoor must be matched	A	-	-	-
Power supply	V	FROM OUTDOOR	FROM OUTDOOR	FROM OUTDOOR
Cable section (interconnection/*if power supply is connected to indoor)	mm²	0.8x 3+EARTH/-	0.8x 3+EARTH/-	0.8x 3+EARTH/-
Piping diameter (Liq / Gas)	Inch	1/4" / 3/8"	1/4" / 3/8"	1/4" / 3/8"
Drain diameter (ext)	in. (mm)	0.63(16)	0.63(16)	0.63(16)
Remote control (standard/optional) *	Standard	RAR-MOB6	RAR-MOB6	RAR-MOB6
	Optional	SPX-WKT4	SPX-WKT4	SPX-WKT4
Filter				
ACL Filter Standard (Material & Accessory code)		activated carbon / SPX-CFH22AC25	activated carbon / SPX-CFH22AC25	activated carbon / SPX-CFH22AC25
ACL Filter Standard Dimensions (H x W x D)	in. (mm)	48x243x5	48x243x5	48x243x5
ACL Filter Optional (Material - Accessory code)		-	-	-
Pre-filter Standard Material		STAINLESS	STAINLESS	STAINLESS
Pre-filter Optional (Material & Accessory code)		-	-	-

NOTE:

1. Capacity and seasonal performance data (SEER /HSPF) are based on AHRI 210-240. The nominal heating and cooling capacity is the combined capacity of the HITACHI Split system (Indoor + Outdoor Unit).

2. The Sound Pressure Level is based on the following conditions:

- 0.8 meter beneath indoor height center
- 1 meter from Discharge grille

The above data was measured in an anechoic chamber so that reflected sound should be taken into consideration when installing the unit.

Operation Conditions		Cooling	Heating
Indoor Air Inlet Temperature	dB	80 °F	70 °F
	WB	67 °F	
Outdoor Air Inlet Temperature	dB	95 °F	47 °F
	WB		43 °F
Piping Length: 7.5 meters; Piping Lift: 0 meter dB: Dry Bulb; WB: Wet Bulb			

1.1.3. FLOOR TYPE (RAF-SH07QHLAE / SH09QHLAE / SH12QHLAE)

INDOOR	Unit	RAF-SH07QHLAE	RAF-SH09QHLAE	RAF-SH12QHLAE
Nominal capacity adjustable		no	no	no
Nominal Cooling capacity (min - max)	BTU	7000(3050-9000)	9000(3050-10600)	12000(3050-13650)
Cooling sensible capacity	BTU	-	-	-
Nominal Heating capacity (min - max)	BTU	9000(3050-10900)	11600(3050-15000)	15350(3050-18000)
Noise level cooling (sound pressure) (SL / L / M / H)	dB(A)	20/26/31/38	20/26/31/38	20/26/31/39
Noise level heating (sound pressure) (SL / L / M / H)	dB(A)	20/26/31/38	20/26/31/38	20/26/31/39
Noise level (sound power) *match with Fiche/ Eurovent/Product Info	dB(A)	52	52	53
Air flow cooling mode (SL / L / M / H)	cfm (m³/h)	159/230/300/371 (270/390/510/630)	159/230/300/371 (270/390/510/630)	159/230/300/371 (270/390/510/630)
Air flow heating mode (SL / L / M / H)	cfm (m³/h)	177/247/318/388 (300/420/540/660)	177/247/318/388 (300/420/540/660)	177/247/318/388 (300/420/540/660)
Fan Motor	W	38	38	38
Dehumidification	l/h	1.2	1.4	1.9
Included drain pump *for RAI/RAD	yes/no	no	no	no
Max. height available for drain pump (RAD/RAI only)	in. (mm)	no	no	no
Drain pump pressure lift *for RAI/RAD	in. (mm)	no	no	no
Static pressure switch at High(L / M / H) *for RAD	Pa (m3/h)	no	no	no
Dimensions (H x W x D)	in. (mm)	23 x 30 x 8 (590 x 750 x 215)	23 x 30 x 8 (590 x 750 x 215)	23 x 30 x 8 (590 x 750 x 215)
Weight *must match with Packing data information	lbs. (kg)	33 (15)	33 (15)	33 (15)
Panel weight *for RAI	lbs. (kg)	-	-	-
Panel dimensions (H x W x D) *for RAI	in. (mm)	-	-	-
Colour (Munsell Code)		ShadowWhite (5PB8.7/0.5)	ShadowWhite (5PB8.7/0.5)	ShadowWhite (5PB8.7/0.5)
Condensate Drain	in. (mm)	0.63(16)	0.63(16)	0.63(16)
Panel reference		-	-	-
Color of the panel (RAL)		-	-	-
Running current (C/H) *for single split indoor&outdoor must be matched	A	-	-	-
Power supply	V	FROM OUTDOOR	FROM OUTDOOR	FROM OUTDOOR
Cable section (interconnection/*if power supply is connected to indoor)	mm²	0.8x 3+EARTH/-	0.8x 3+EARTH/-	0.8x 3+EARTH/-
Piping diameter (Liq / Gas)	Inch	1/4" / 3/8"	1/4" / 3/8"	1/4" / 3/8"
Drain diameter (ext)	in. (mm)	0.63(16)	0.63(16)	0.63(16)
Remote control (standard/optional) *	Standard	RAR-MOB3	RAR-MOB3	RAR-MOB3
	Optional	SPX-RCDB1/ SPX-WKT4	SPX-RCDB1/ SPX-WKT4	SPX-RCDB1/ SPX-WKT4
Filter				
ACL Filter Standard (Material & Accessory code)		activated carbon / SPX-CFH22AC25	activated carbon / SPX-CFH22AC25	activated carbon / SPX-CFH22AC25
ACL Filter Standard Dimensions (H x W x D)	in. (mm)	48x243x5	48x243x5	48x243x5
ACL Filter Optional (Material - Accessory code)		-	-	-
Pre-filter Standard Material		STAINLESS	STAINLESS	STAINLESS
Pre-filter Optional (Material & Accessory code)		-	-	-

NOTE:

1. Capacity and seasonal performance data (SEER /HSPF) are based on AHRI 210-240. The nominal heating and cooling capacity is the combined capacity of the HITACHI Split system (Indoor + Outdoor Unit).

2. The Sound Pressure Level is based on the following conditions:

- 0.8 meter beneath indoor height center
- 1 meter from Discharge grille

The above data was measured in an anechoic chamber. Please take into consideration reflected sound of your specific site

Operation Conditions		Cooling	Heating
Indoor Air Inlet Temperature	dB	80 °F	70 °F
	WB	67 °F	
Outdoor Air Inlet Temperature	dB	95 °F	47 °F
	WB		43 °F
Piping Length: 7.5 meters; Piping Lift: 0 meter dB: Dry Bulb; WB: Wet Bulb			

1.1.4. CEILING CASSETTE (RAI-SH07QHLAE / SH09QHLAE)

INDOOR	Unit	RAI-SH07QHLAE	RAI-SH09QHLAE
Nominal capacity adjustable		no	no
Nominal Cooling capacity (min - max)	BTU	7000(3050-8500)	9000(3050-10200)
Cooling sensible capacity	BTU	-	-
Nominal Heating capacity (min - max)	BTU	9000(3050-10900)	12000(3050-18000)
Noise level cooling (sound pressure) (SL / L / M / H)	dB(A)	27/31/35/38	27/31/35/38
Noise level heating (sound pressure) (SL / L / M / H)	dB(A)	28/32/36/39	28/32/36/39
Noise level (sound power) *match with Fiche/ Eurovent/Product Info	dB(A)	54	54
Air flow cooling mode (SL / L / M / H)	cfm (m³/h)	212/297/347/388 (360/505/590/660)	212/297/347/388 (360/505/590/660)
Air flow heating mode (SL / L / M / H)	cfm (m³/h)	261/318/371/424 444/540/630/720	261/318/371/424 444/540/630/720
Fan Motor	W	57	57
Dehumidification	l/h	1.2	1.4
Included drain pump *for RAI/RAD	yes/no	Yes	Yes
Max. height available for drain pump (RAD/RAI only)	in. (mm)	33(850)	33(850)
Drain pump pressure lift *for RAI/RAD	in. (mm)	4.5(115)	4.5(115)
Static pressure switch at High(L / M / H) *for RAD	Pa (m3/h)	no	no
Dimensions (H x W x D)	in. (mm)	11 x 22 x 22 (285 x 570 x 570)	11 x 22 x 22 (285 x 570 x 570)
Weight *must match with Packing data information	lbs. (kg)	37 (17)	37 (17)
Panel weight *for RAI	lbs. (kg)	6.17 (2.8)	6.17 (2.8)
Panel dimensions (H x W x D) *for RAI	in. (mm)	1.2 x 24.4 x 24.4 (30 x 620 x 620)	1.2 x 24.4 x 24.4 (30 x 620 x 620)
Colour (Munsell Code)		-	-
Condensate Drain	in. (mm)	1.26 (32)	1.26 (32)
Panel reference		-	-
Color of the panel (RAL)		-	-
Running current (C/H) *for single split indoor&outdoor must be matched	A	-	-
Power supply	V	FROM OUTDOOR	FROM OUTDOOR
Cable section (interconnection/**if power supply is connected to indoor)	mm²	0.8x 3+EARTH/-	0.8x 3+EARTH/-
Piping diameter (Liq / Gas)	Inch	1/4" / 3/8"	1/4" / 3/8"
Drain diameter (ext)	in. (mm)	1.26 (32)	1.26 (32)
Remote control (standard/optional) *	Standard	RAR-MOB3	RAR-MOB3
	Optional	SPX-RCDB1/SPX-WKT4	SPX-RCDB1/SPX-WKT4
Filter			
ACL Filter Standard (Material & Accessory code)		-	-
ACL Filter Standard Dimensions (H x W x D)	in. (mm)	-	-
ACL Filter Optional (Material - Accessory code)		-	-
Pre-filter Standard Material		NORMAL	NORMAL
Pre-filter Optional (Material & Accessory code)		-	-

NOTE:

1. Capacity and seasonal performance data (SEER /HSPF) are based on AHRI 210-240. The nominal heating and cooling capacity is the combined capacity of the HITACHI Split system (Indoor + Outdoor Unit).

2. The Sound Pressure Level is based on the following conditions:

- 1.5 meter beneath the unit

The above data was measured in an anechoic chamber so that reflected sound should be taken into consideration when installing the unit.

Operation Conditions		Cooling	Heating
Indoor Air Inlet Temperature	dB	80 °F	70 °F
	WB	67 °F	
Outdoor Air Inlet Temperature	dB	95 °F	47 °F
	WB		43 °F
Piping Length: 7.5 meters; Piping Lift: 0 meter dB: Dry Bulb; WB: Wet Bulb			

1.1.5. CEILING CASSETTE (RAI-SH12QHLAE)

INDOOR	Unit	RAI-SH12QHLAE
Nominal capacity adjustable		no
Nominal Cooling capacity (min - max)	BTU	12000(3050-13650)
Cooling sensible capacity	BTU	-
Nominal Heating capacity (min - max)	BTU	16400(3050-22500)
Noise level cooling (sound pressure) (SL / L / M / H)	dB(A)	29/35/39/43
Noise level heating (sound pressure) (SL / L / M / H)	dB(A)	30/36/40/44
Noise level (sound power) *match with Fiche/ Eurovent/Product Info	dB(A)	56
Air flow cooling mode (SL / L / M / H)	cfm (m³/h)	212/297/347/388 (360/505/590/660)
Air flow heating mode (SL / L / M / H)	cfm (m³/h)	261/318/371/424 444/540/630/720
Fan Motor	W	57
Dehumidification	l/h	1.4
Included drain pump *for RAI/RAD	yes/no	Yes
Max. height available for drain pump (RAD/RAI only)	in. (mm)	33(850)
Drain pump pressure lift *for RAI/RAD	in. (mm)	4.5(115)
Static pressure switch at High(L / M / H) *for RAD	Pa (m3/h)	no
Dimensions (H x W x D)	in. (mm)	11 x 22 x 22 (285 x 570 x 570)
Weight *must match with Packing data information	lbs. (kg)	37 (17)
Panel weight *for RAI	lbs. (kg)	6.17 (2.8)
Panel dimensions (H x W x D) *for RAI	in. (mm)	1.2 x 24.4 x 24.4 (30 x 620 x 620)
Colour (Munsell Code)		-
Condensate Drain	in. (mm)	1.26 (32)
Panel reference		-
Color of the panel (RAL)		-
Running current (C/H) *for single split indoor&outdoor must be matched	A	-
Power supply	V	FROM OUTDOOR
Cable section (interconnection/*if power supply is connected to indoor)	mm²	0.8x 3+EARTH/-
Piping diameter (Liq / Gas)	Inch	1/4" / 3/8"
Drain diameter (ext)	in. (mm)	1.26 (32)
Remote control (standard/optional) *	Standard	RAR-MOB3
	Optional	SPX-RCDB1/SPX-WKT4
Filter		
ACL Filter Standard (Material & Accessory code)		-
ACL Filter Standard Dimensions (H x W x D)	in. (mm)	-
ACL Filter Optional (Material - Accessory code)		-
Pre-filter Standard Material		NORMAL
Pre-filter Optional (Material & Accessory code)		-

NOTE:

1. Capacity and seasonal performance data (SEER /HSPF) are based on AHRI 210-240. The nominal heating and cooling capacity is the combined capacity of the HITACHI Split system (Indoor + Outdoor Unit).

2. The Sound Pressure Level is based on the following conditions:

- 1.5 meter beneath the unit

The above data was measured in an anechoic chamber so that reflected sound should be taken into consideration when installing the unit.

Operation Conditions		Cooling	Heating
Indoor Air Inlet Temperature	dB	80 °F	70 °F
	WB	67 °F	
Outdoor Air Inlet Temperature	dB	95 °F	47 °F
	WB		43 °F
Piping Length: 7.5 meters; Piping Lift: 0 meter dB: Dry Bulb; WB: Wet Bulb			

1.1.5. DUCT TYPE (RAD-SH07QHLAE / SH09QHLAE / SH12QHLAE)

INDOOR	Unit	RAD-SH07QHLAE	RAD-SH09QHLAE	RAD-SH12QHLAE
Nominal capacity adjustable		no	no	no
Nominal Cooling capacity (min - max)	BTU	7000(3050-8500)	9000(3050-10200)	12000(3050-13650)
Cooling sensible capacity	BTU	-	-	-
Nominal Heating capacity (min - max)	BTU	9000(3050-10900)	12000(3050-18000)	16400(3050-22500)
Noise level cooling (sound pressure) (SL / L / M / H)	dB(A)	30/33/37/41	30/33/37/41	30/33/37/41
Noise level heating (sound pressure) (SL / L / M / H)	dB(A)	30/34/38/42	30/34/38/42	30/34/38/42
Noise level (sound power) *match with Fiche/ Eurovent/Product Info	dB(A)	57	57	57
Air flow cooling mode (SL / L / M / H)	cfm (m³/h)	194/229/264/300 (330/390/450/510)	194/229/264/300 (330/390/450/510)	194/229/264/300 (330/390/450/510)
Air flow heating mode (SL / L / M / H)	cfm (m³/h)	194/229/264/300 (330/390/450/510)	194/229/264/300 (330/390/450/510)	194/229/264/300 (330/390/450/510)
Fan Motor	W	20	20	20
Dehumidification	l/h	1.4	1.4	1.6
Included drain pump *for RAI/RAD	yes/no	yes	yes	yes
Max. height available for drain pump (RAD/RAI only)	in. (mm)	33(850)	33(850)	33(850)
Drain pump pressure lift *for RAI/RAD	in. (mm)	4.5(115)	4.5(115)	4.5(115)
Static pressure switch at High(L / M / H) *for RAD	Pa (m3/h)	70	70	70
Dimensions (H x W x D)	in. (mm)	9x29x15 (235x750x400)	9x29x15 (235x750x400)	9x29x15 (235x750x400)
Weight *must match with Packing data information	lbs. (kg)	35 (16)	35 (16)	35 (16)
Panel weight *for RAI	lbs. (kg)	-	-	-
Panel dimensions (H x W x D) *for RAI	in. (mm)	-	-	-
Colour (Munsell Code)		-	-	-
Condensate Drain	in. (mm)	0.63(16)	0.63(16)	0.63(16)
Panel reference		-	-	-
Color of the panel (RAL)		-	-	-
Running current (C/H) *for single split indoor&outdoor must be matched	A	-	-	-
Power supply	V	FROM OUTDOOR	FROM OUTDOOR	FROM OUTDOOR
Cable section (interconnection/**if power supply is connected to indoor)	mm²	0.8x 3+EARTH/-	0.8x 3+EARTH/-	0.8x 3+EARTH/-
Piping diameter (Liq / Gas)	Inch	1/4", 3/8"	1/4", 3/8"	1/4", 3/8"
Drain diameter (ext)	in. (mm)	0.63 (16)	0.63 (16)	0.63 (16)
Remote control (standard/optional) *	Standard	RAR-MOB4	RAR-MOB4	RAR-MOB4
	Optional	SPX-RCDA1/SPX-WKT4	SPX-RCDA1/SPX-WKT4	SPX-RCDA1/SPX-WKT4
Filter				
ACL Filter Standard (Material & Accessory code)		-	-	-
ACL Filter Standard Dimensions (H x W x D)	in. (mm)	-	-	-
ACL Filter Optional (Material - Accessory code)		-	-	-
Pre-filter Standard Material		NORMAL	NORMAL	NORMAL
Pre-filter Optional (Material & Accessory code)		-	-	-

NOTE:

1. Capacity and seasonal performance data (SEER /HSPF) are based on AHRI 210-240. The nominal heating and cooling capacity is the combined capacity of the HITACHI Split system (Indoor + Outdoor Unit).

2. The Sound Pressure Level is based on the following conditions:

- 1.5 meter beneath the unit

The above data was measured in an anechoic chamber. Please take into consideration reflected sound of your specific site

Operation Conditions		Cooling	Heating
Indoor Air Inlet Temperature	dB	80 °F	70 °F
	WB	67 °F	
Outdoor Air Inlet Temperature	dB	95 °F	47 °F
	WB		43 °F
Piping Length: 7.5 meters; Piping Lift: 0 meter dB: Dry Bulb; WB: Wet Bulb			

1.1.7. DUCT STATIC PRESSURE AND AIR FLOW (RAD-SH07/09/12QHLAE)

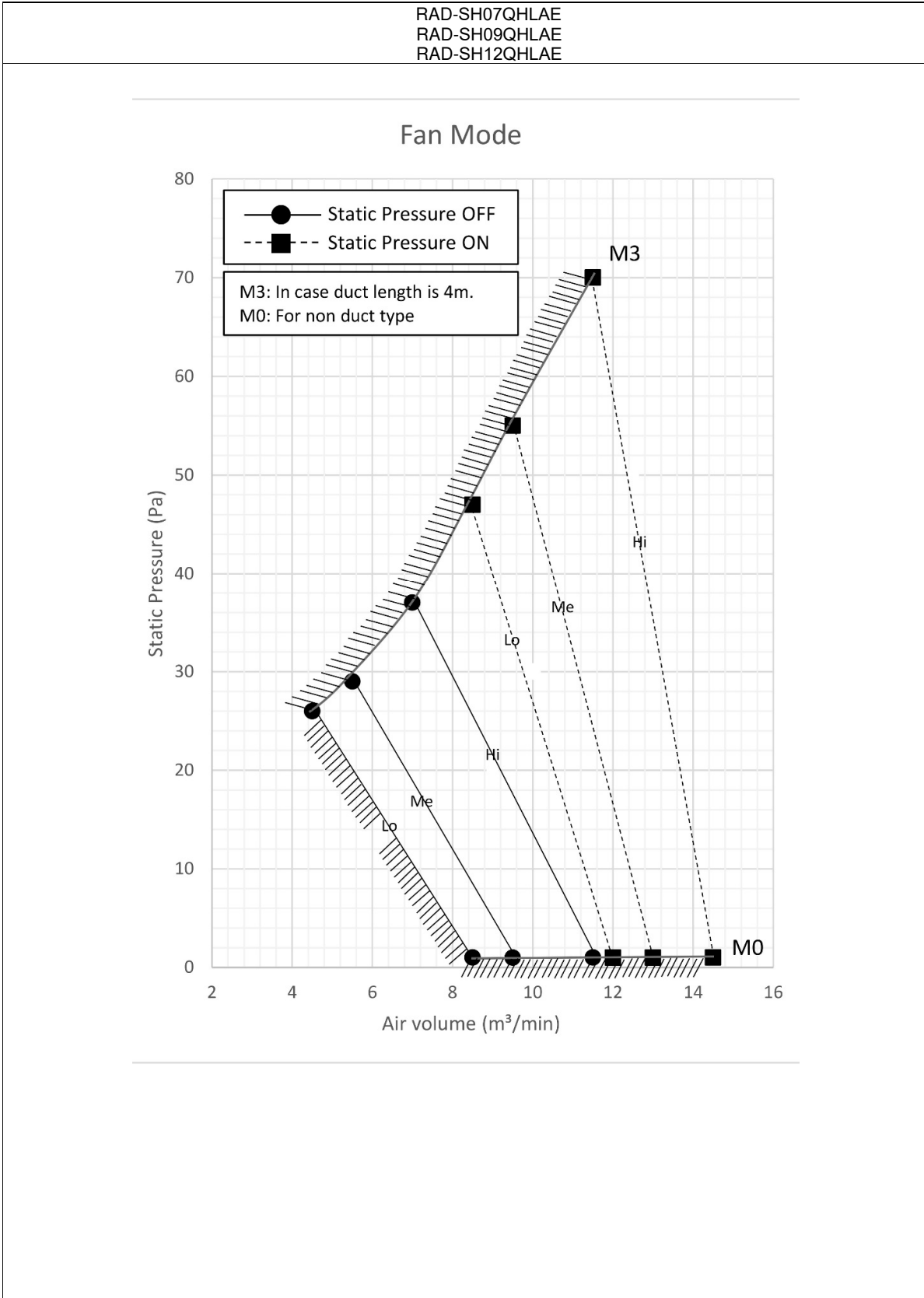

1.2. RAM-S18U2HLAE

OUTDOOR	UNIT	RAM-S18U2HLAE
Minimum / Maximum indoor units connectable (for MULTI only)		2
Minimum / Maximum connected indoor capacity (for MULTI only)	kBTU	14/ 24
Nominal Cooling capacity (min - max) *for single split indoor&outdoor must be matched	BTU	18000(7000~21000)
Nominal Heating capacity (min - max) *for single split indoor&outdoor must be matched	BTU	22000(9000~24500)
Nominal cooling power input (min - max)	kW	1.44(0.46 -2.40)
Nominal heating power input (min - max)	kW	1.95(0.46 -2.30)
EER(T1condition)	Btu/W	12.5
COP (H1 condition)	Btu/W	11.3
SEER / SCOP *average climate		22.0 / 10.3
Noise level cooling (sound pressure)	dB(A)	50
Noise level heating (sound pressure)	dB(A)	52
Noise level - ODU (sound power)	dB(A)	64
Air flow (Cooling / Heating)	cfm (m ³ /h)	1271(2160)/1271(2160)
Dimensions (H x W x D)	in. (mm)	30x33x12(750x850x298)
Net weight	lbs. (kg)	112 (51)
Colour (Munsell Code)		Beige (5Y7/2)
Power supply	V/Ph/Hz	208- 230V / 1Ph / 60Hz
Recommended fuse size	A	20
Starting current(rated current of COOL/HEAT whichever higher for inverter)	A	6.99/ 9.42
Running current (C/H) *for single split indoor&outdoor must be matched	A	6.32 / 8.52
Cable section (power)	mm ²	2.50x 2+EARTH
Interconnection between indoor unit and outdoor unit	mm ²	0.80x 3+EARTH
Piping diameter (Liq / Gas) *for single split indoor&outdoor must be matched	Inch	(1/4" / 3/8")X2
Minimum piping length	ft. (m)	16(5)
Maximum piping length / height difference	ft. (m)	164(50)/66(20)
Current quantity of refrigerant / Chargeless	lbs. (kg)	3.97(1.8)
Chargeless length / Additional refrigerant charge	m / g/m	30 / 15
Working range (cooling / heating)	°F(°C)	14 to 115 (-10 to +46)
	°F(°C)	-4 to 75 (-20 to +24)
Refrigerant		R410A
Condenser Fan		Propeller Fan
Compressor	Type	2 Cylinder Rotary
	Oil Type	α68HES-H or equivalent
	Oil Charge l	520±20 ml
	Coil resistance	1.31Ω at 20°C
	Quantity	1

NOTE:

- The Sound Pressure Level is based on the following conditions:
 - Half height of the unit
 - 1 meter from Discharge grille

The above data was measured in an anechoic chamber. Please take into consideration reflected sound of your specific site

2 DIMENSIONAL DATA

CONTENTS

2	DIMENSIONAL DATA	2-1
2.1.	MULTIZONE INDOOR UNITS	2-2
2.1.1.	WALL TYPE (RAS-EH07QHLAE, RAS-EH09/12RHLAE)	2-2
2.1.2.	WALL TYPE (RAS-SH07QHLAE, RAS-SH09/12RHLAE)	2-3
2.1.3.	FLOOR TYPE (RAF-SH07/09/12QHLAE)	2-4
2.1.4.	CEILING CASSETTE (RAI- SH07/09/12QHLAE)	2-5
2.1.5.	DUCT TYPE (RAD-SH07/09/12QHLAE)	2-6
2.2.	MULTIZONE OUTDOOR UNITS (RAM-S18U2HLAE)	2-7

2.1. MULTIZONE INDOOR UNITS

2.1.1. WALL TYPE: RAS-EH07QHLAE / EH09RHLAE / EH12RHLAE

Unit: mm

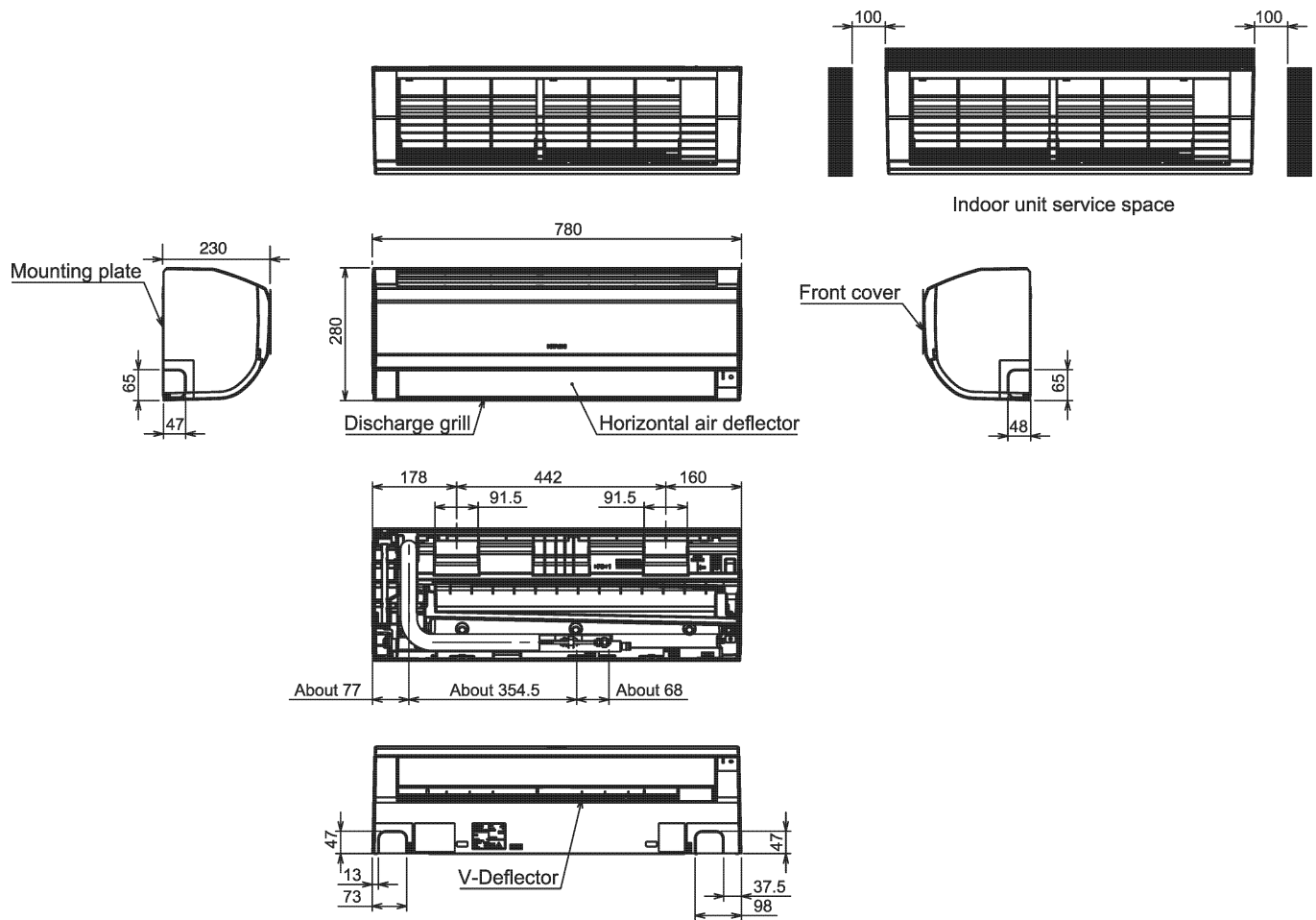

2.1.2. WALL TYPE: RAS-SH07QHLAE / SH09RHLAE / SH12RHLAE

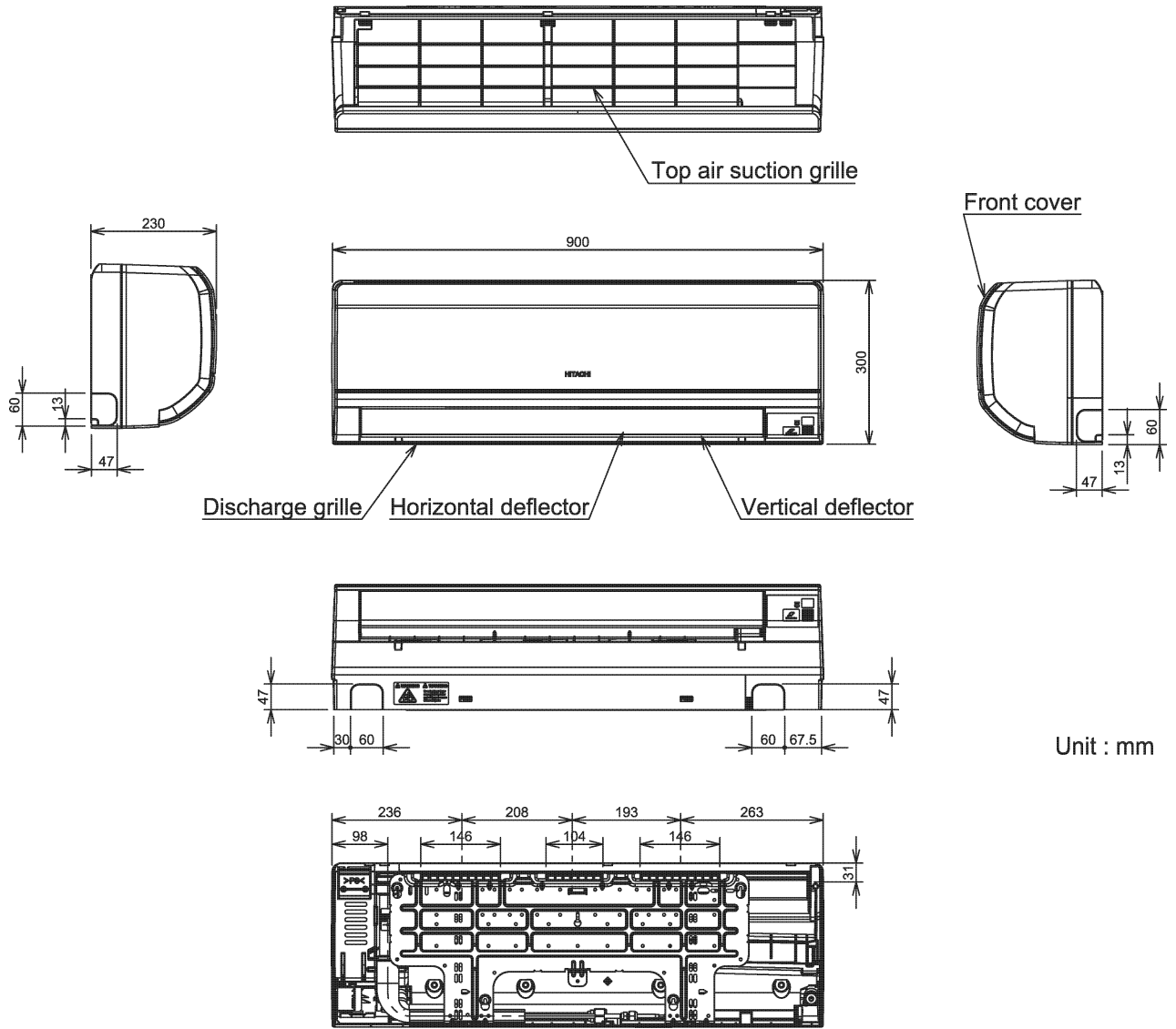

Unit : mm

2.1.3. FLOOR TYPE: RAF-SH07QHLAE / SH09QHLAE / SH12QHLAE

Unit : mm

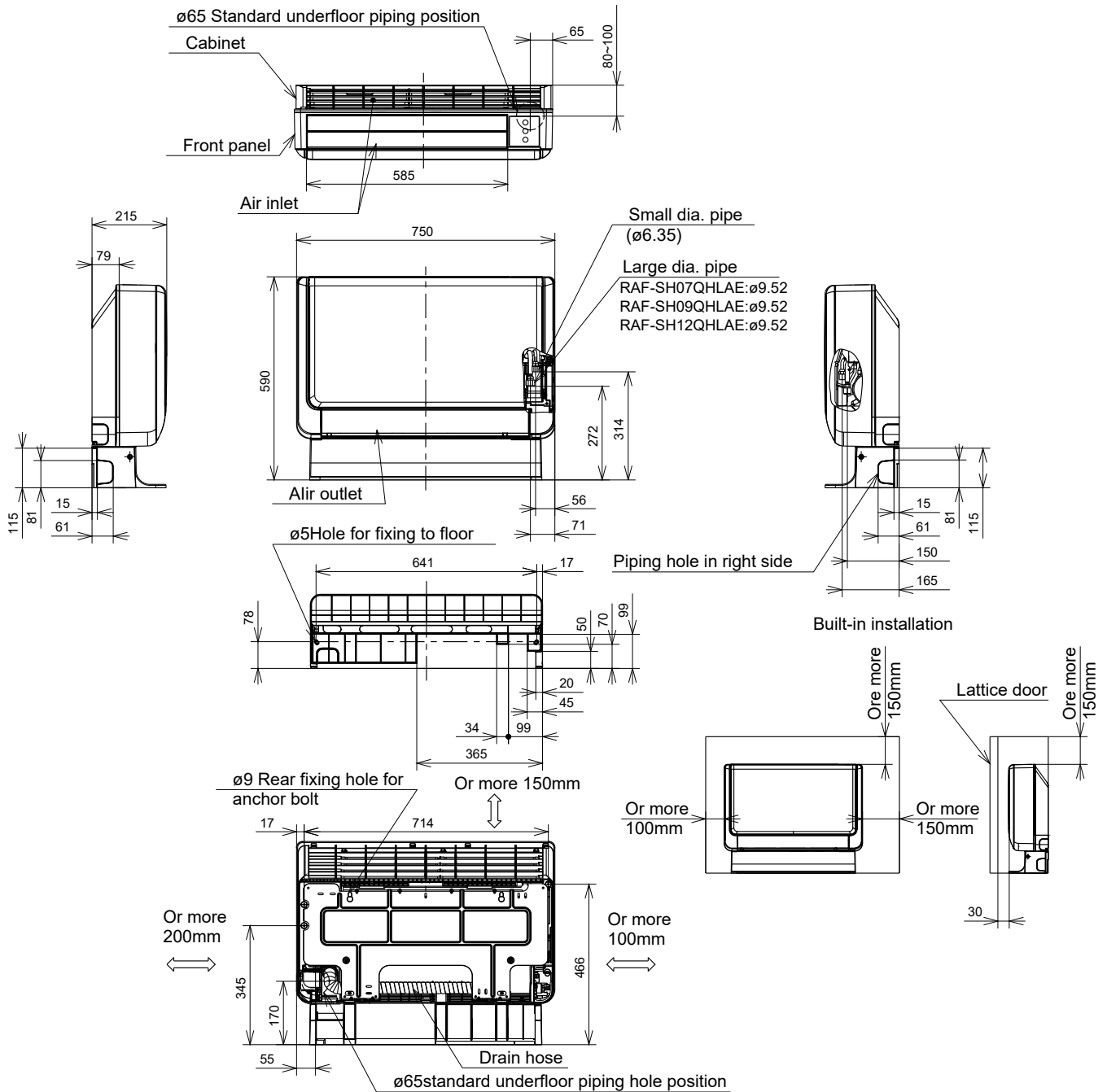

2.1.4. CEILING CASSETTE TYPE: RAI-SH07QHLAE / SH09QHLAE / SH12QHLAE

Unit: mm

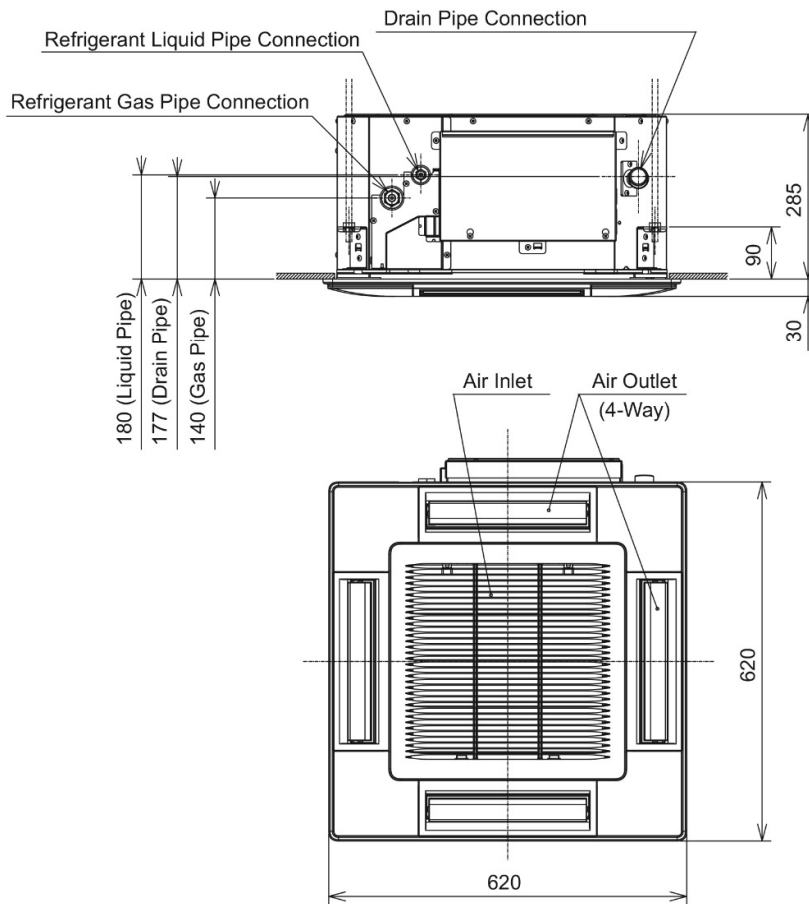
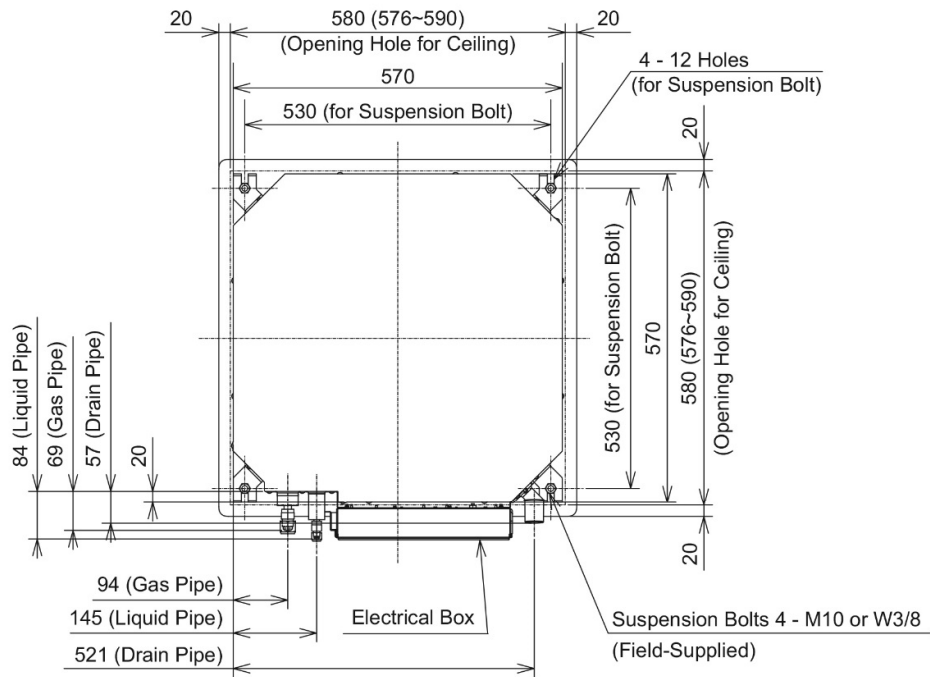

2.1.5. DUCT TYPE: RAD-SH07QHLAE / SH09QHLAE / SH12QHLAE

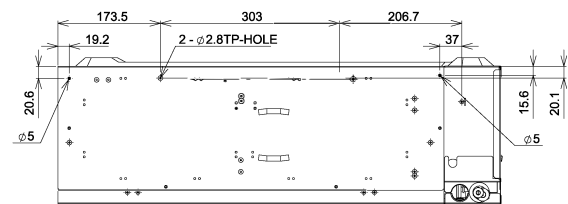
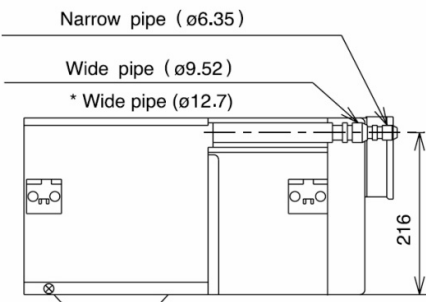
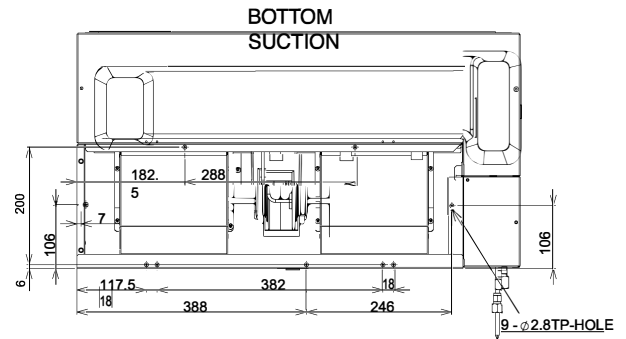
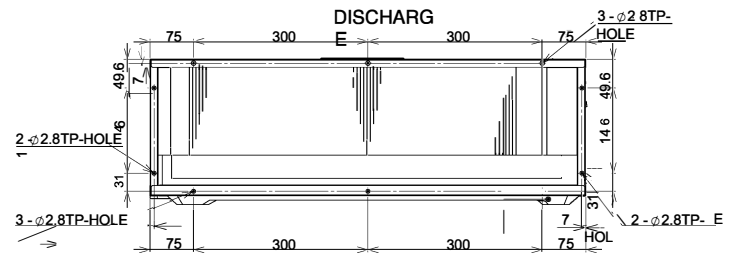
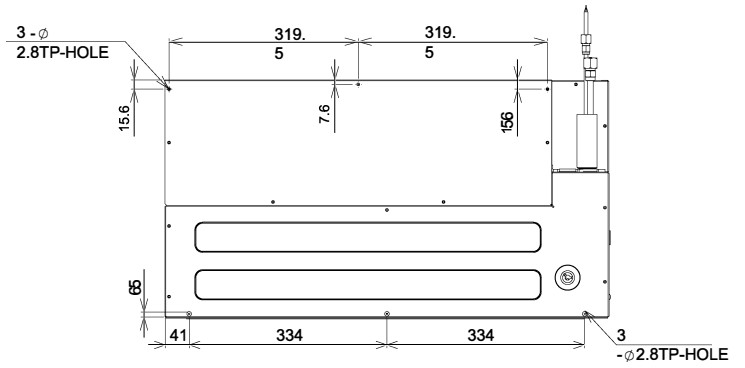
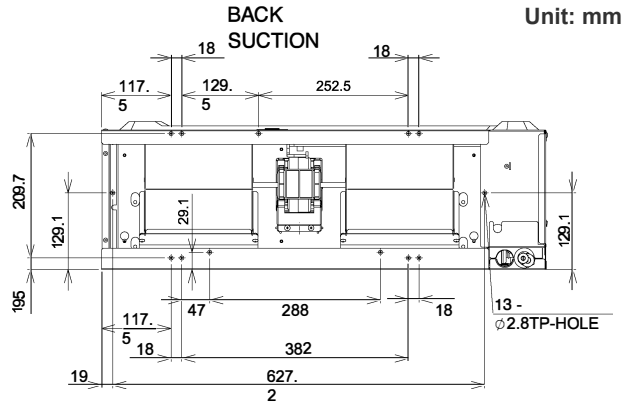
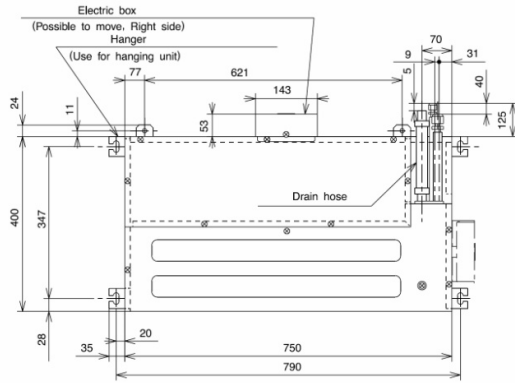

2.2 2 ROOMS MULTIZONE: RAM-S18U2HLAE

Unit: mm

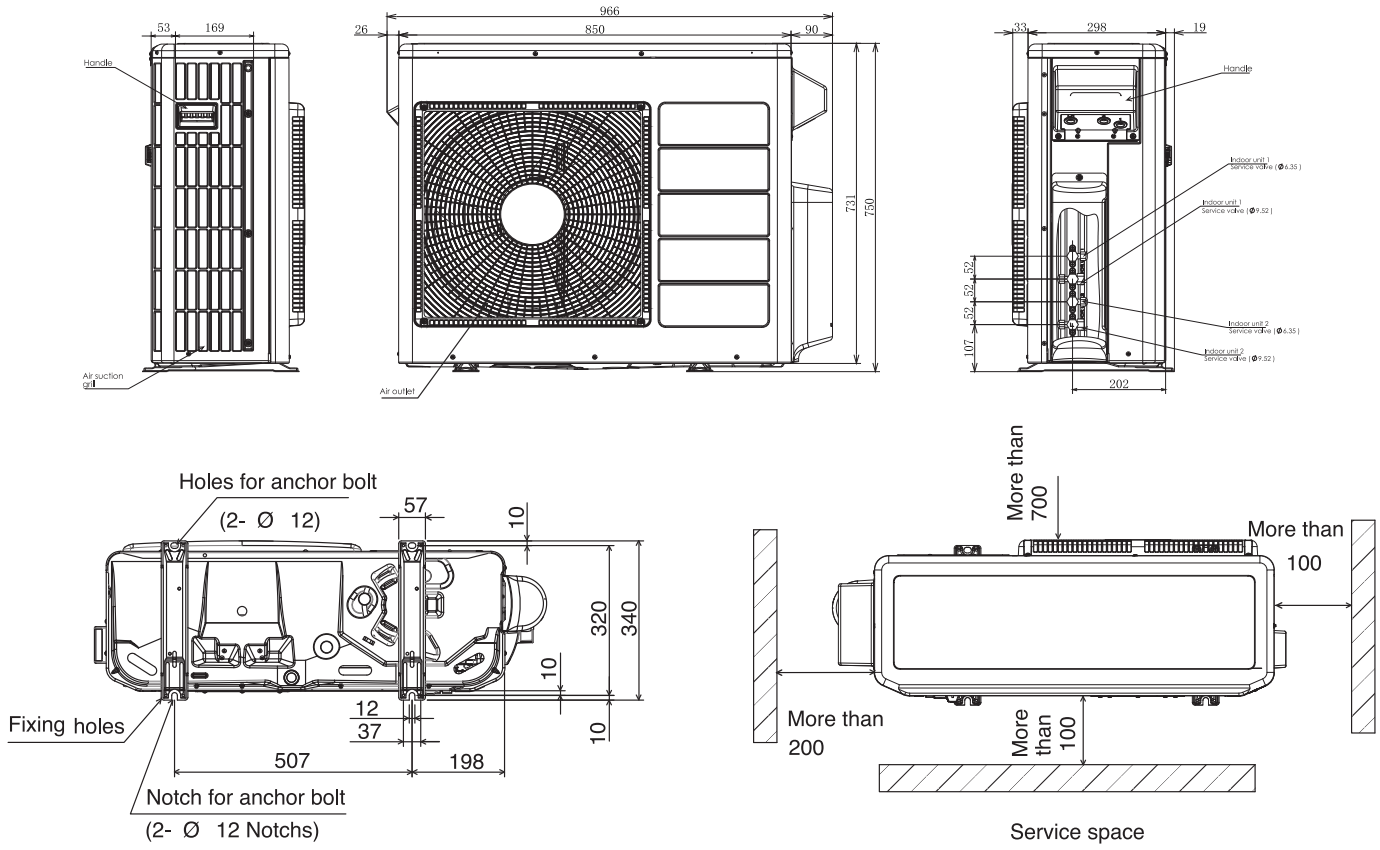

3 CAPACITIES AND SELECTION DATA

CONTENTS

3	CAPACITIES AND SELECTION DATA	3-1
3.1.	SYSTEM SELECTION PROCEDURE	3-2
3.1.1.	SELECTION UNIT FEATURES	3-2
3.1.2.	SELECTION GUIDE	3-2
3.2.	CAPACITY CHARACTERISTIC CURVES FOR MULTIZONE	3-3
3.3.	CORRECTION FACTORS ACCORDING TO PIPING LENGTH	3-8
3.4.	CORRECTION FACTORS ACCORDING TO DEFROSTING OPERATION	3-10
3.5.	COMBINATION TABLE FOR MULTIZONE OUTDOOR	3-11

3.1. SYSTEM SELECTION PROCEDURE

The following system procedure is giving a sample regarding unit selection system, indicating how to use all parameters showed in this chapter.

3.1.1. SELECTION UNIT FEATURES

Considering the building distribution, the possible indoor unit position and the available air flow distribution, select the unit features that are giving the best efficiency and comfort to each room.

Decide the Outdoor Unit position getting easy service maintenance and easy refrigerant pipe installation.

Therefore, the maximum indoor unit capacity combined with outdoor unit should be carefully considered for correct indoor unit distribution at each building

3.1.2. SELECTION GUIDE

The following guide giving the method for indoor and outdoor unit selection.

* Step 1: Determine the system requirements

Calculate the cooling capacity and heating capacity of each indoor unit according to the following conditions:

Total Load for each room

Item		Room		
		1	2	1+2
Estimated Cooling Load	kW	2.60	2.60	5.20
Estimated Heating Load	kW	3.25	3.25	6.50

*Example

Temperature Condition

Cooling	Heating
Outdoor Air Inlet • Dry Bulb: 95°F	Outdoor Air Inlet • Dry Bulb: 47°F • Wet Bulb: 43°F
Indoor Air Inlet • Dry Bulb: 80°F • Wet Bulb: 67°F	Indoor Air Inlet • Dry Bulb: 70°F

*Example

* Step 2: Select Unit Capacity Performance

The unit kW is selected following the Cooling capacity and Heating capacity showed in the combination table.

* Step 3: Read Selected Capacity Performance

The unit performance should be calculated considering the following correction factors:

1. Cooling and Heating piping length
2. Outdoor unit performance capacity
3. Indoor unit performance capacity for each room cooling load

Kindly refer to the unit selection combination table for correct capacity performance.

7K+12K	54	64	14940	10254	890	16920	13673	1057	15660	12621	1245	14760	11964	1375	14220	11438	1435	13320	10780	1540	12780	10254	1600
	57	68	14940	10254	890	18180	13673	1057	16920	12752	1260	15840	11964	1390	15300	11569	1450	14220	10780	1555	13680	10386	1630
	61	72	14940	10912	904	19440	13673	1071	18000	12752	1275	16920	11964	1405	16380	11569	1480	15300	10780	1585	14760	10386	1645
	64	77	16020	11701	918	20700	14856	1084	19080	13804	1289	18000	13015	1420	17280	12489	1480	16200	11701	1600	15480	11175	1659
	66	81	16560	12095	932	21420	15645	1098	19800	14461	1304	18720	13673	1435	18000	13147	1495	16920	12358	1600	16200	11832	1659
	72	86	18360	11964	932	23760	15513	1098	21960	14330	1304	20700	13541	1450	19980	13015	1510	18000	12621	1659	16740	12358	1749
75	90	19620	11964	945	25380	15513	1112	23400	14330	1319	22140	13541	1450	21240	13015	1525	18720	12884	1704	17100	12752	1809	
9K+9K	54	64	14940	11487	857	16920	15316	1018	15660	14138	1200	14760	13402	1325	14220	12812	1382	13320	12076	1483	12780	11487	1541
	57	68	14940	11487	857	18180	15316	1018	16920	14285	1214	15840	13402	1339	15300	12960	1397	14220	12076	1498	13680	11634	1570
	61	72	14940	12223	870	19440	15316	1031	18000	14285	1228	16920	13402	1354	16380	12960	1426	15300	12076	1526	14760	11634	1584
	64	77	16020	13107	884	20700	16642	1045	19080	15463	1242	18000	14580	1368	17280	13991	1426	16200	13107	1541	15480	12518	1598
	66	81	16560	13549	897	21420	17525	1058	19800	16200	1256	18720	15316	1382	18000	14727	1440	16920	13843	1541	16200	13254	1598
	72	86	18360	13402	897	23760	17378	1058	21960	16052	1256	20700	15169	1397	19980	14580	1454	18000	14138	1598	16740	13843	1685
75	90	19620	13402	911	25380	17378	1071	23400	16052	1270	22140	15169	1397	21240	14580	1469	18720	14432	1642	17100	14285	1742	
9K+12K	54	64	14940	12129	982	16920	16172	1166	15660	14928	1374	14760	14151	1518	14220	13529	1584	13320	12751	1700	12780	12129	1766
	57	68	14940	12129	982	18180	16172	1166	16920	15084	1391	15840	14151	1535	15300	13684	1601	14220	12751	1716	13680	12285	1799
	61	72	14940	12907	997	19440	16172	1182	18000	15084	1407	16920	14151	1551	16380	13684	1634	15300	12751	1749	14760	12285	1815
	64	77	16020	13840	1013	20700	17572	1197	19080	16328	1423	18000	15395	1568	17280	14773	1634	16200	13840	1766	15480	13218	1832
	66	81	16560	14306	1028	21420	18505	1212	19800	17105	1439	18720	16172	1584	18000	15550	1650	16920	14617	1766	16200	13995	1832
	72	86	18360	14151	1028	23760	18349	1212	21960	16950	1439	20700	16017	1601	19980	15395	1667	18000	14928	1832	16740	14617	1931
75	90	19620	14151	1043	25380	18349	1228	23400	16950	1455	22140	16017	1601	21240	15395	1683	18720	15239	1881	17100	15084	1997	
12K+12K	54	64	14940	12769	1107	16920	17025	1315	15660	15715	1549	14760	14897	1711	14220	14242	1786	13320	13423	1916	12780	12769	1990
	57	68	14940	12769	1107	18180	17025	1315	16920	15879	1568	15840	14897	1730	15300	14406	1804	14220	13423	1934	13680	12932	2027
	61	72	14940	13587	1124	19440	17025	1332	18000	15879	1586	16920	14897	1748	16380	14406	1841	15300	13423	1972	14760	12932	2046
	64	77	16020	14569	1142	20700	18498	1349	19080	17189	1604	18000	16206	1767	17280	15552	1841	16200	14569	1990	15480	13915	2065
	66	81	16560	15060	1159	21420	19480	1367	19800	18007	1622	18720	17025	1786	18000	16370	1860	16920	15388	1990	16200	14733	2065
	72	86	18360	14897	1159	23760	19317	1367	21960	17843	1622	20700	16861	1804	19980	16206	1879	18000	15715	2065	16740	15388	2176
75	90	19620	14897	1176	25380	19317	1384	23400	17843	1641	22140	16861	1804	21240	16206	1897	18720	16043	2120	17100	15879	2251	

EWB : Evaporator Wet Bulb temperature (°F)
 EDB : Evaporator Dry Bulb temperature (°F)
 (°FDB) : Outdoor Unit Inlet Air Dry Temperature (°F)

TC : Total Capacity (Btu)
 SHC : Sensible Heating Capacity (Btu)
 PI : Power Input (W)

3.3. CORRECTION FACTORS ACCORDING TO PIPING LENGTH

Correction Factor for **Cooling Capacity** according to Piping Length

The cooling capacity should be corrected according to the following formula:

$$CCA = CC \times F$$

CCA: Actual Corrected Cooling Capacity (kcal/h)

CC: Cooling Capacity in the Performance Table (kcal/h)

F: Correction Factor Based on the Equivalent Piping Length

Correction Factor for **Heating Capacity** according to Piping Length

The heating capacity should be corrected according to the following formula:

$$HCA = HC \times F$$

HCA: Actual Corrected Heating Capacity (kcal/h)

HC: Heating Capacity in the Performance Table (kcal/h)

F: Correction Factor Based on the Equivalent Piping Length

The correction factors are shown in the following figure.

Equivalent Piping Length for:

- One 90° Elbow is 0.5m.
- One 180° Curve is 1.5m.

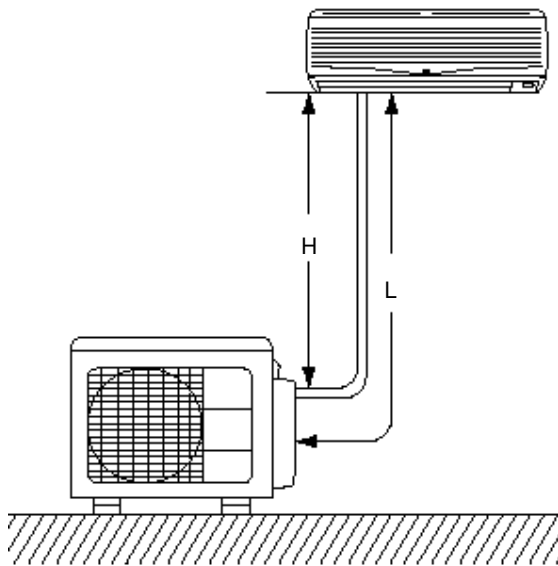

H: Vertical Distance Between Indoor Unit and Outdoor Units in Meters

L: Actual One-Way Piping Length Between Indoor Unit and Outdoor Unit in Meters

EL: Equivalent Total Distance Between Indoor Unit and Outdoor Unit in Meters (Equivalent One-Way Piping Length)

Model Multi Outdoor 18000 BTU/h

RAM-S18U2HLAE

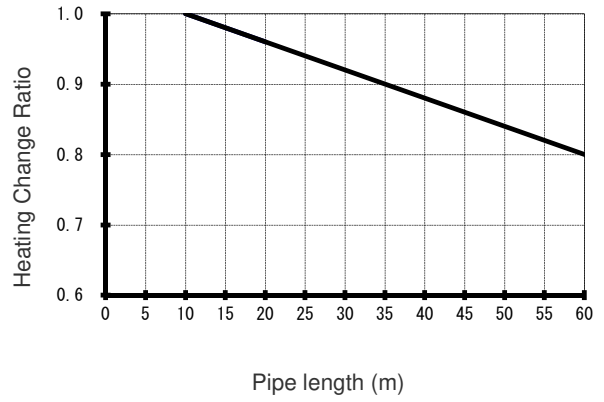
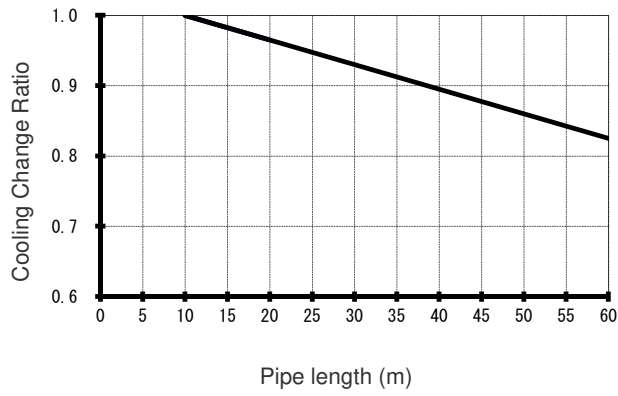

3.4. CORRECTION FACTORS ACCORDING TO DEFROSTING OPERATION

The heating capacity in the preceding paragraph, excludes the condition of the frost or the defrosting operation period. In consideration of the frost or the defrosting operation, the heating capacity is corrected by the equation below.

Corrected heating capacity = Defrost Correction factor x unit capacity

OUTDOOR TEMPERATURE (°CDB)	-15	-10	-7	-5	0	7	10	15
Correction factor (humidity rate 85% RH)	0.95	0.95	0.89	0.85	0.81	1.0	1.0	1.0

Correction Factor

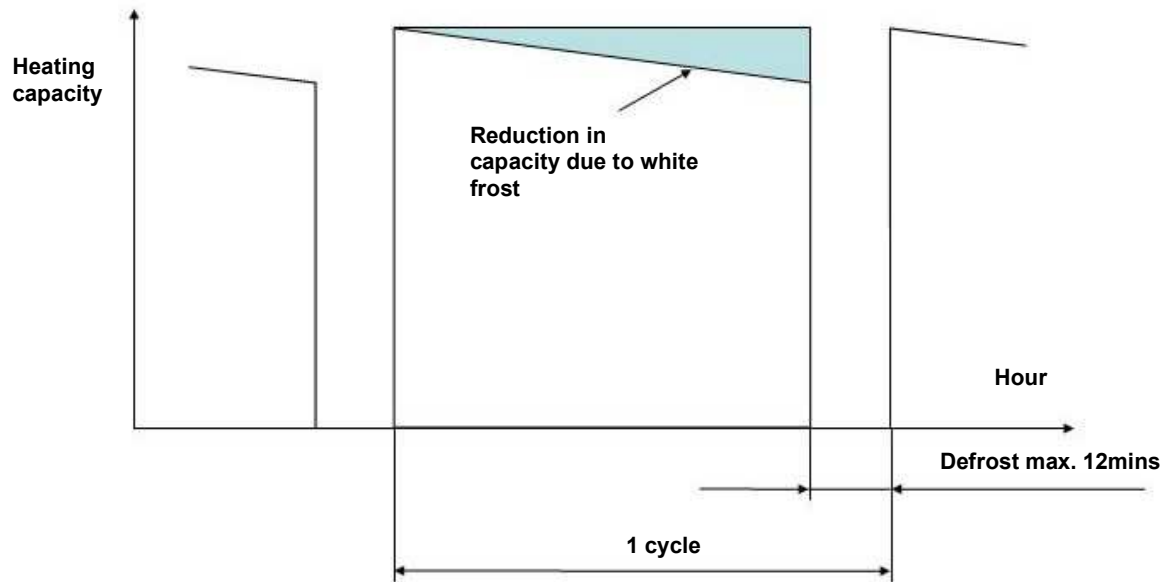

NOTE:

The correction factor is not valid for special conditions such as snowfall or operation in a transitional period.

3.5. COMBINATION TABLE FOR MULTIZONE OUTDOOR

Whichever indoor units are installed, cooling and heating capacity depends on how many and which indoor units are operating at that time.

2 ROOM MULTI-SPLIT INVERTER TYPE RAC: RAM-S18U2HLAE POSSIBLE COMBINATION TO OPERATE (SAME TIME OPERATION)

POSSIBLE COMBINATIONS TO OPERATE(Btu)			COOLING						HEATING					
			CAPACITY RATING(Btu) (RANGE)		TOTAL	OUTDOOR UNIT		EER	CAPACITY RATING(Btu) (RANGE)		TOTAL	OUTDOOR UNIT		COP
						POWER CONSUMPTIO N (W)	AMPERE(A)					POWER CONSUMPTIO N (W)	AMPERE(A)	
ONE UNIT	7k	7k	7000 (3050~8500)	7000	750 (460~900)	3.61 - 3.26	9.33	9000 (3050~10900)	9000	850 (460~1450)	4.09 - 3.70	10.59		
	9k	9k	9000 (3050~10200)	9000	820 (460~1000)	3.94 - 3.57	10.98	11600 (3050~15000)	11600	1100 (460~1600)	5.29 - 4.78	10.55		
	12k	12k	12000 (3050~13650)	12000	980 (460~1100)	4.71 - 4.26	12.24	15350 (3050~18000)	15350	1250 (460~1700)	6.01 - 5.43	12.28		
TWO UNIT	14k	7k+7k	7000+7000 (7000~18000)	14000	1220 (460~1600)	6.01 - 5.30	11.48	9000+9000 (9000~21000)	18000	1250 (460~1900)	6.01 - 5.43	14.40		
	16k	7k+9k	7000+9000 (7000~18700)	16000	1330 (460~1800)	6.39 - 5.78	12.03	9000+11600 (9000~23000)	20600	1400 (460~2000)	6.73 - 6.09	14.71		
	19k	7k+12k	7000+11000 (7000~19800)	18000	1510 (460~2100)	7.26 - 6.57	11.92	8100+13900 (9000~24500)	22000	2050 (460~2100)	9.86 - 8.91	10.73		
	18k	9k+9k	9000+9000 (7000~19400)	18000	1440 (460~2000)	6.92 - 6.26	12.50	11000+11000 (9000~24500)	22000	1950 (460~2100)	9.38 - 8.48	11.28		
	21k	9k+12k	7650+10350 (7000~21000)	18000	1600 (460~2200)	7.69 - 6.96	11.25	9500+12500 (9000~24500)	22000	2100 (460~2100)	10.10 - 9.13	10.48		
	24k	12k+12k	9000+9000 (7000~21000)	18000	1700 (460~2200)	8.17 - 7.39	10.59	11000+11000 (9000~24500)	22000	2100 (460~2100)	10.10 - 9.13	10.48		

<REMARKS>

- * ONE UNIT INDICATED ARE ONLY FOR ONE UNIT OPERATION WHEN TWO OR THREE OR FOUR INDOOR UNITS ARE CONNECTED.
- * TWO UNITS INDICATED ARE ONLY FOR TWO UNIT OPERATION WHEN TWO OR THREE OR FOUR INDOOR UNITS ARE CONNECTED.
- * THREE UNITS INDICATED ARE ONLY FOR THREE UNIT OPERATION WHEN THREE OR FOUR INDOOR UNITS ARE CONNECTED.
- * TOTAL NOMINAL COOLING CAPACITY SHOULD NOT BE MORE THAN 21K Btu.

RATING CONDITON (DRY BLUB / WET BULB)

	INDOOR °F (°C)	OUTDOOR °F (°C)
COOLING	80/67 (26.67/19.44)	95/75 (35/23.89)
HEATING	70/60 (21.11/15.56)	47/43 (8.33/6.11)

NOMINAL COOLING CAPACITY(Btu)	INDOOR UNIT MODEL	CAPACITY(Btu) at one unit operation		SUITABLE ROOM SIZE(m ²) at one unit operation	
		COOLING	HEATING	COOLING	HEATING
7k	RAS-SH07QHLAE	3050~9000	3050~10900	8-12	9-11
	RAS-EH07QHLAE	3050~9000	3050~10900	8-12	9-11
	RAD-SH07QHLAE	3050~8500	3050~10900	8-12	9-11
	RAI-SH07QHLAE	3050~8500	3050~10900	8-12	9-11
	RAF-SH07QHLAE	3050~9000	3050~10900	8-12	9-11
9k	RAS-SH09RHLAE	5100~10500	5450~15000	11-17	14-18
	RAS-EH09RHLAE	5450~10500	4200~11500	11-17	14-18
	RAD-SH09QHLAE	3050~10200	3050~18000	11-17	14-18
	RAI-SH09QHLAE	3050~10200	3050~18000	11-17	14-18
	RAF-SH09QHLAE	3050~10600	3050~15000	11-17	14-18
12k	RAS-SH12RHLAE	5150~14000	5500~18000	16-24	17-22
	RAS-EH12RHLAE	5500~13200	4400~14500	16-24	17-22
	RAD-SH12QHLAE	3050~13650	3050~22500	16-24	17-22
	RAI-SH12QHLAE	3050~13650	3050~22500	16-24	17-22
	RAF-SH12QHLAE	3050~13650	3050~18000	16-24	17-22

*Two, three, four or five indoor units can be installed with one outdoor unit.

*One-unit values are for one unit operation with two indoors connected.

*Total nominal cooling capacity should not be more than 21K Btu.

4 SOUND DATA

CONTENTS

4	SOUND DATA _____	4-1
4.1.	SOUND DATA (RAM-S18U2HLAE) _____	4-2

4.1 RAM-S18U2HLAE

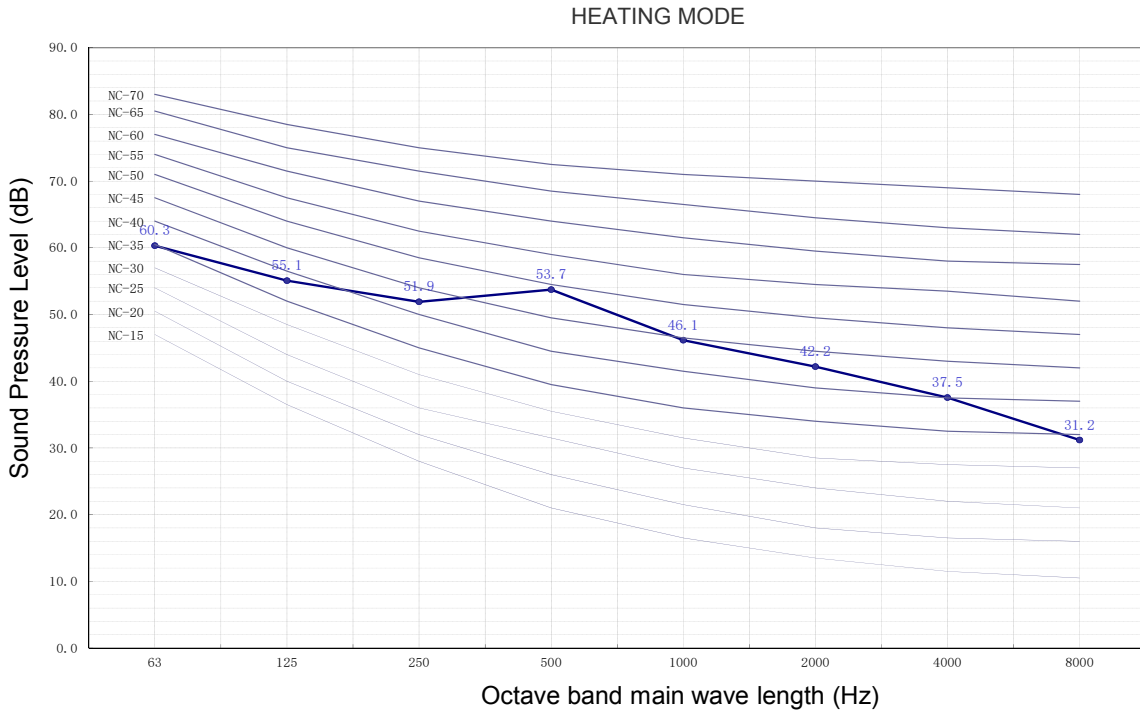
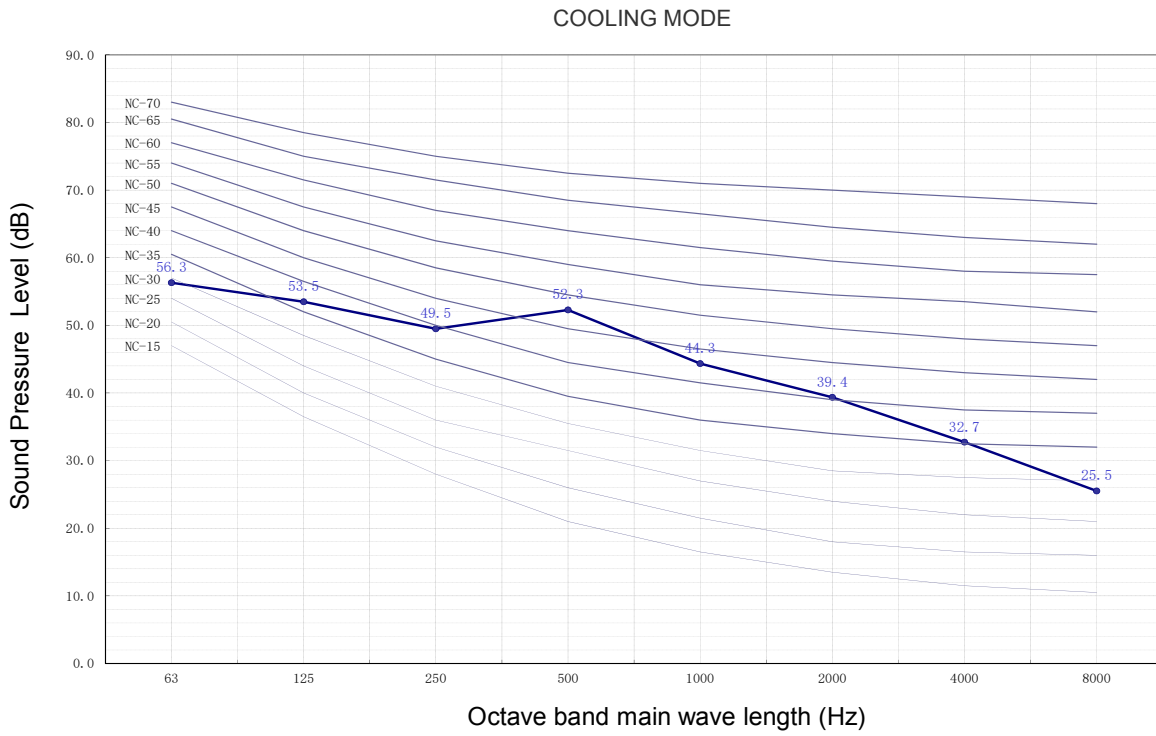

The Sound Pressure Level is based on the following conditions:

1 meter from the unit front surface and 1 meter from floor level

The above data was measured in an anechoic chamber. Please take into consideration reflected sound of your specific site

5 WORKING RANGE

CONTENTS

5	WORKING RANGE _____	5-1
5.1.	POWER SUPPLY _____	5-2
5.2.	WORKING RANGE _____	5-2
5.2.1.	MULTIZONE _____	5-2

5.1. POWER SUPPLY

Working Voltage	198V ~ 264V
Voltage Imbalance	Within a 3% Deviation from Each Voltage at the Main Terminal of Outdoor Unit
Starting Voltage	Higher than 85% of the Rated Voltage

5.2. WORKING RANGE

5.2.1. MULTIZONE

Applicable models:

MULTIZONE
RAM-S18U2HLAE

The temperature range is indicated in the following table.

Cooling

working range	min (°C)	max (°C)	rated (°C)
outdoor	-10	46	35
indoor	16	32	26.67

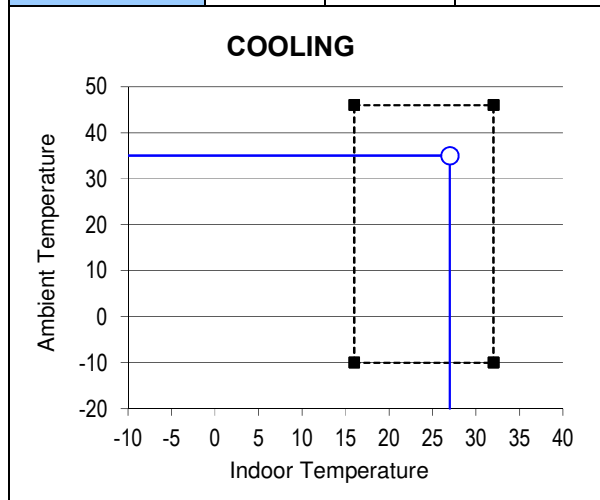

Heating

working range	min (°C)	max (°C)	rated (°C)
outdoor	-20	24	8.33
indoor	16	27	21.11

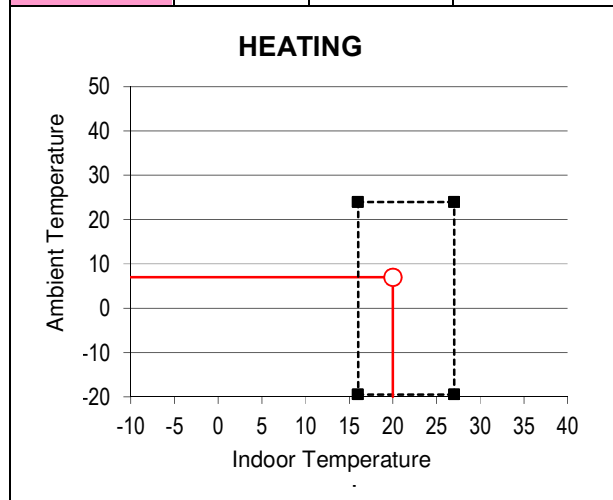

6 ELECTRICAL DATA

CONTENTS

6	ELECTRICAL DATA _____	6-1
6.1.	INDOOR UNIT _____	6-2
6.2.	OUTDOOR UNIT _____	6-3

6.1. INDOOR UNIT

Model	Unit Main Power	Rated input current of power conversion equipment	Indoor Fan Motor	
	VOL, PH, Hz		RNC	IPT
RAS-EH07QHLAE	208-230, 1, 60	0.45	0.67	38
RAS-EH09RHLAE	208-230, 1, 60	0.45	0.67	38
RAS-EH12RHLAE	208-230, 1, 60	0.45	0.67	38
RAS-SH07QHLAE	208-230, 1, 60	0.62	0.67	30
RAS-SH09RHLAE	208-230, 1, 60	0.62	0.67	30
RAS-SH12RHLAE	208-230, 1, 60	0.62	0.67	30
RAF-SH07QHLAE	208-230, 1, 60	0.25	0.75	38
RAF-SH09QHLAE	208-230, 1, 60	0.25	0.75	38
RAF-SH12QHLAE	208-230, 1, 60	0.25	0.75	38
RAI-SH07QHLAE	208-230, 1, 60	0.80	0.25	57
RAI-SH09QHLAE	208-230, 1, 60	0.80	0.25	57
RAI-SH12QHLAE	208-230, 1, 60	0.80	0.25	57
RAD-SH07QHLAE	208-230, 1, 60	0.45	0.11	20
RAD-SH09QHLAE	208-230, 1, 60	0.45	0.11	20
RAD-SH12QHLAE	208-230, 1, 60	0.45	0.11	20

VOL: Rated Unit Power Supply Voltage (V)
 Hz: Frequency (Hz)

RNC: Running Current (A)
 PH: Phase (ϕ)
 IPT: Input (W)

6.2. OUTDOOR UNIT

Model	Unit Main Power		Electrical Data			
	VOL, PH, Hz	Rated input current of power conversion equipment (A)	Rated Cooling Current	Rated Heating Current	MCA	MOP
RAM-S18U2HLAE	208-230, 1, 60	13	6.32	8.52	17	25

VOL: Rated Unit Power Supply Voltage (V)

MCA: Minimum Circuit Ampacity (A)

HZ: Frequency (Hz)

MOP: Maximum Overcurrent Protection (A)

PH: Phase (ϕ)

- NOTE:**
1. The above compressor data is based on 100% capacity combination of indoor units at the rated operating frequency
 2. This data is based on the same conditions as the nominal heating and cooling capacities.
 3. The compressor started by an inverter, resulting in extremely low starting current.

7 WIRING DIAGRAM

CONTENTS

7	WIRING DIAGRAM	7-1
7.1.	MULTIZONE	7-2
7.1.1.	RAS-EH07QHLAE, RAS-EH09/12RHLAE	7-2
7.1.2.	RAS-SH07QHLAE, RAS-SH09/12RHLAE	7-3
7.1.3.	RAF-SH07/09/12QHLAE	7-4
7.1.4.	RAI- SH07/09/12QHLAE	7-5
7.1.5.	RAD-SH07/09/12QHLAE	7-6
7.2	RAM-S18U2HLAE	7-7

7.1. MULTIZONE

7.1.1. RAS-EH07QHLAE, RAS-EH09/12RHLAE

BLU : BLUE	YEL : YELLOW	BRN : BROWN	WHT : WHITE
GRY : GRAY	ORN : ORANGE	GRN : GREEN	RED : RED
BLK : BLACK	PNK : PINK	VIO : VIOLET	IVO : IVORY

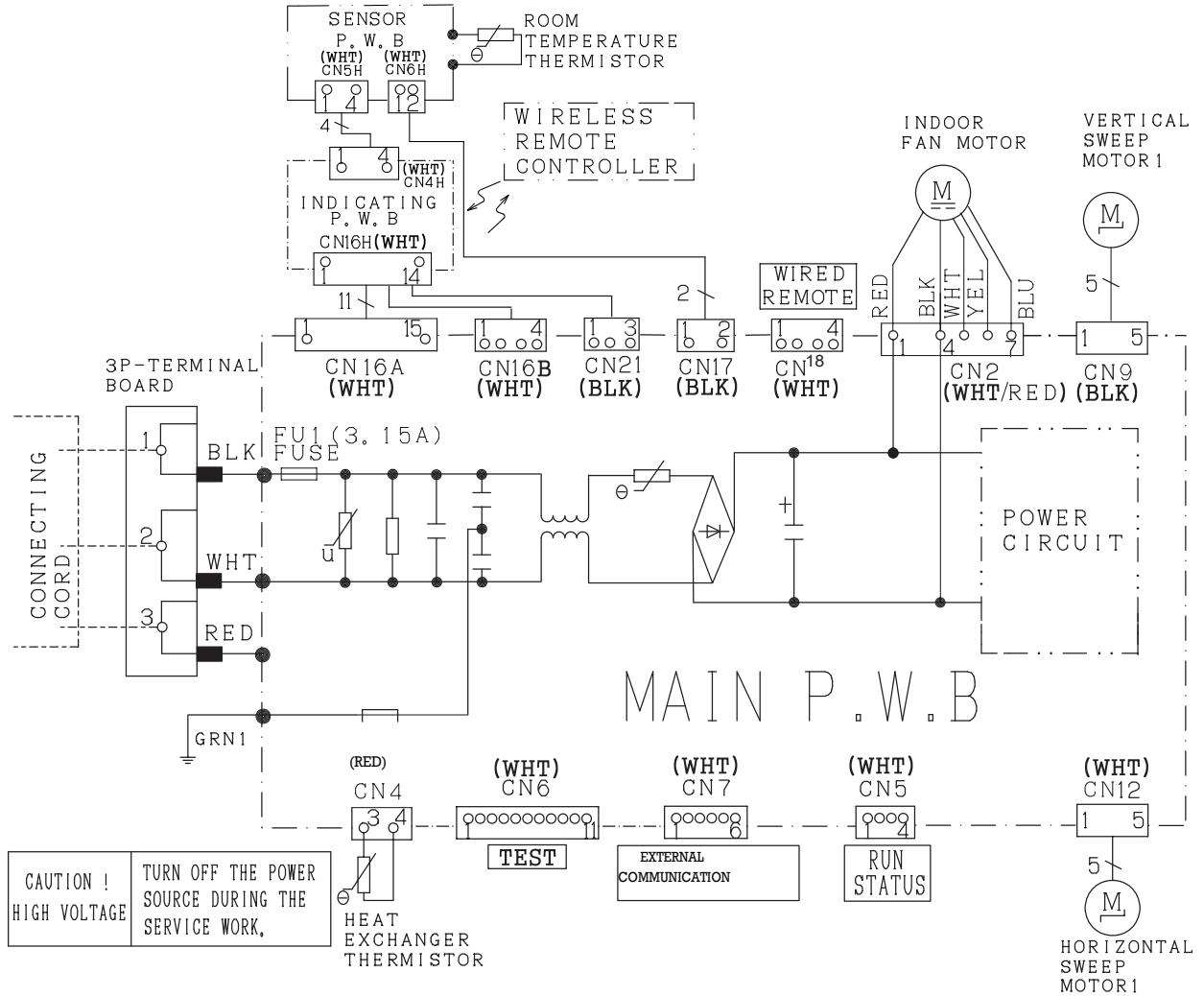

CAUTION ! HIGH VOLTAGE
TURN OFF THE POWER SOURCE DURING THE SERVICE WORK,

7.1.2. RAS-SH07QHLAE, RAS-SH09/12RHLAE

BLU : BLUE	YEL : YELLOW	BRN : BROWN	WHT : WHITE
GRY : GRAY	ORN : ORANGE	GRN : GREEN	RED : RED
BLK : BLACK	PNK : PINK	VIO : VIOLET	IVO : IVORY

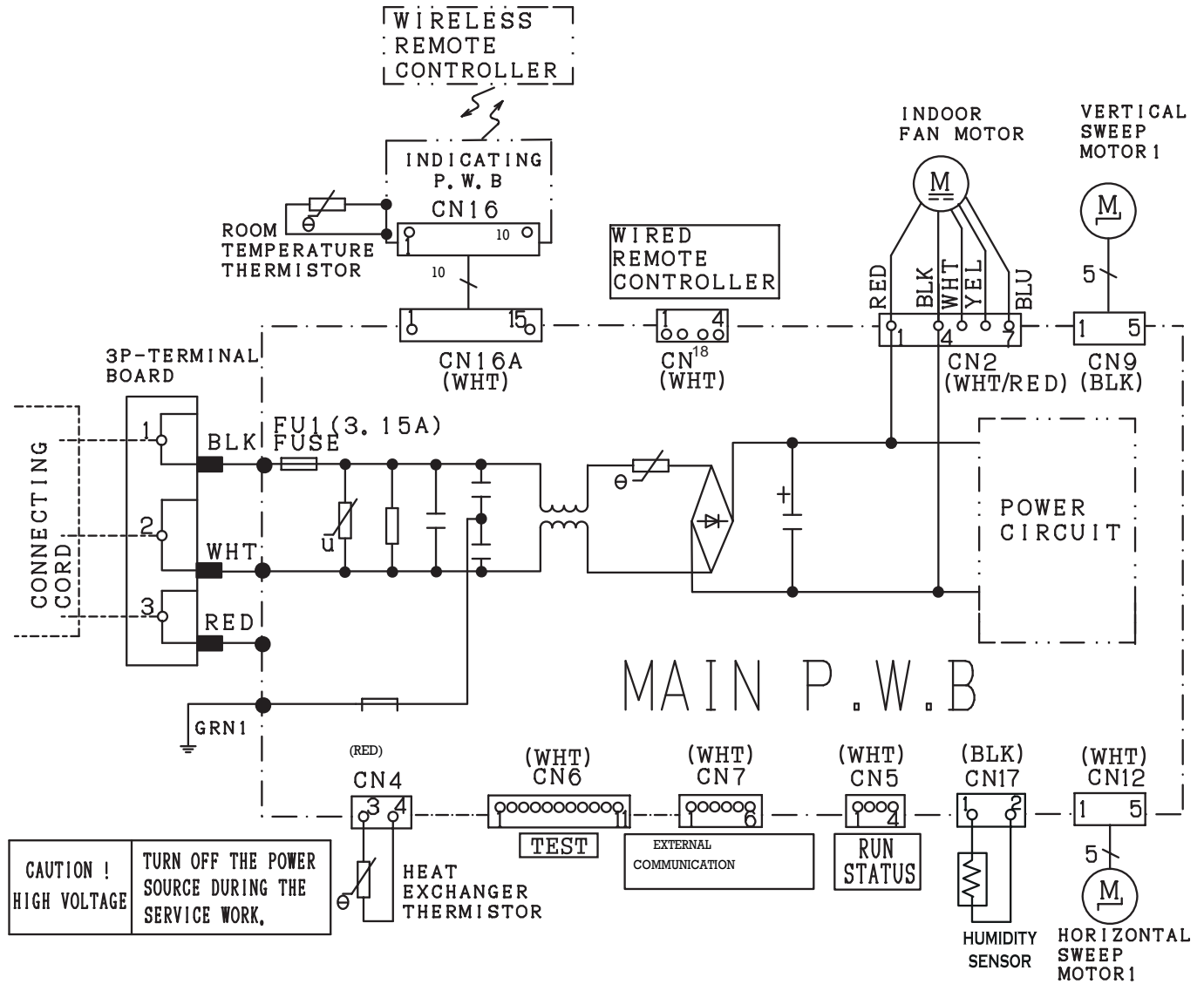

7.1.3. RAF-SH07QHLAE, RAF-SH09QHLAE, RAF-SH12QHLAE

BLK:BLACK GRN:GREEN
 RED:RED WHT:WHITE
 GRY:GRAY YEL:YELLOW
 BLU:BLUE

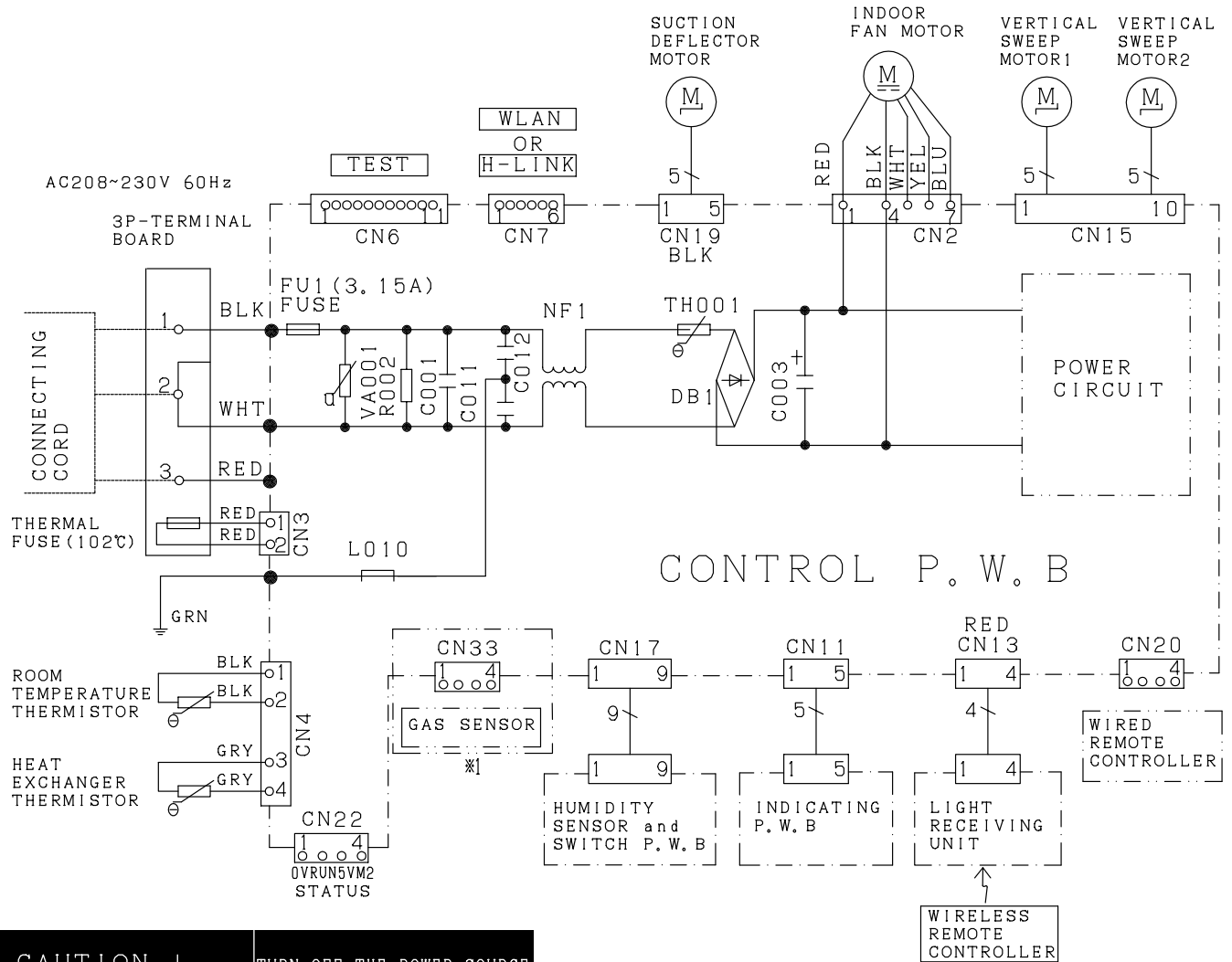

CAUTION !
 HIGH VOLTAGE TURN OFF THE POWER SOURCE
 DURING THE SERVICE WORK.

*1 SOME MODELS NOT NEED TO INSTALL THE CIRCUITS IN DASH DOT,

7.1.4. RAI-SH07QHLAE, RAI-SH09QHLAE, RAI-SH12QHLAE

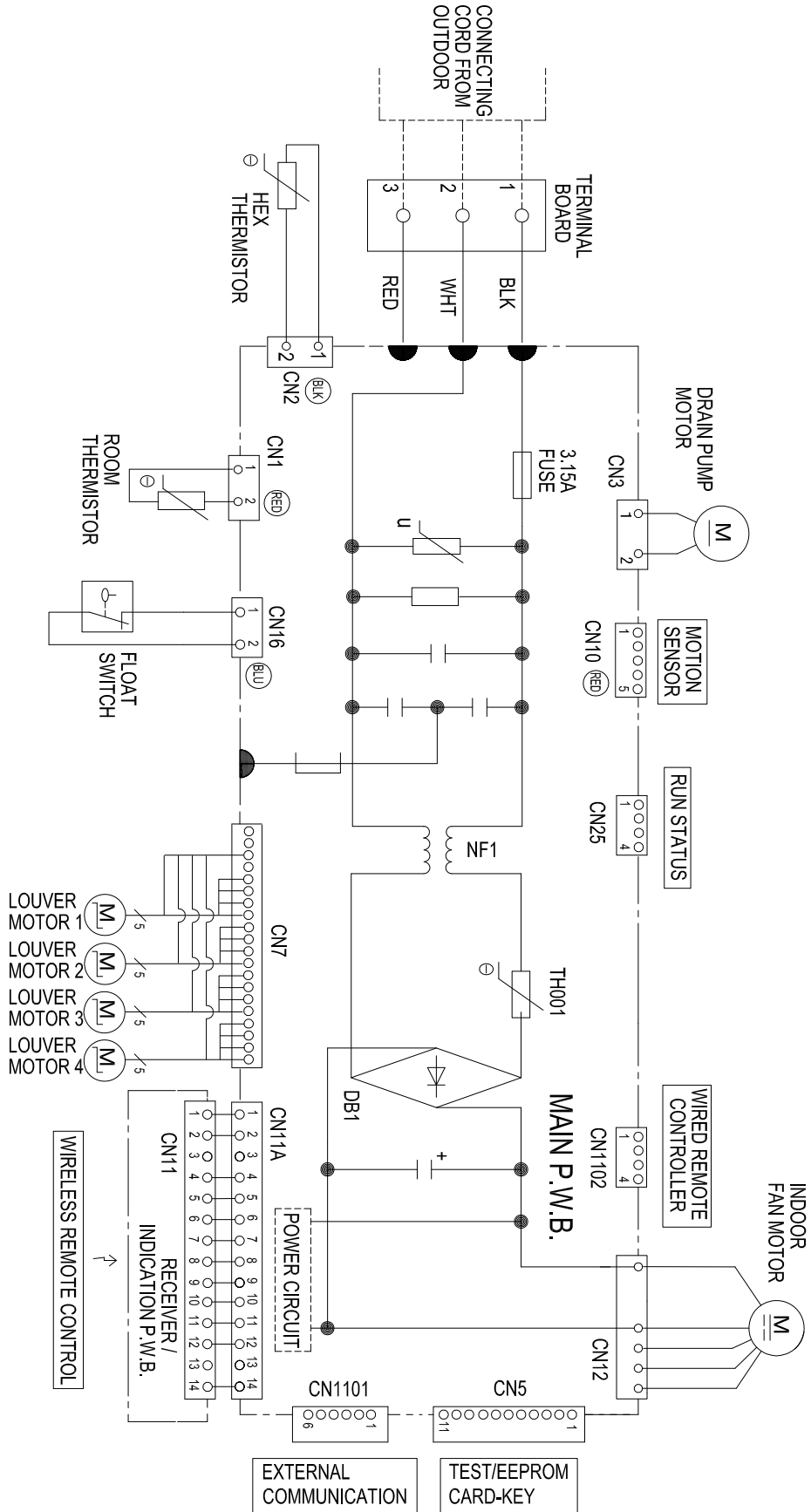

7.1.5. RAD-SH07QHLAE, RAD-SH09QHLAE, RAD-SH12QHLAE

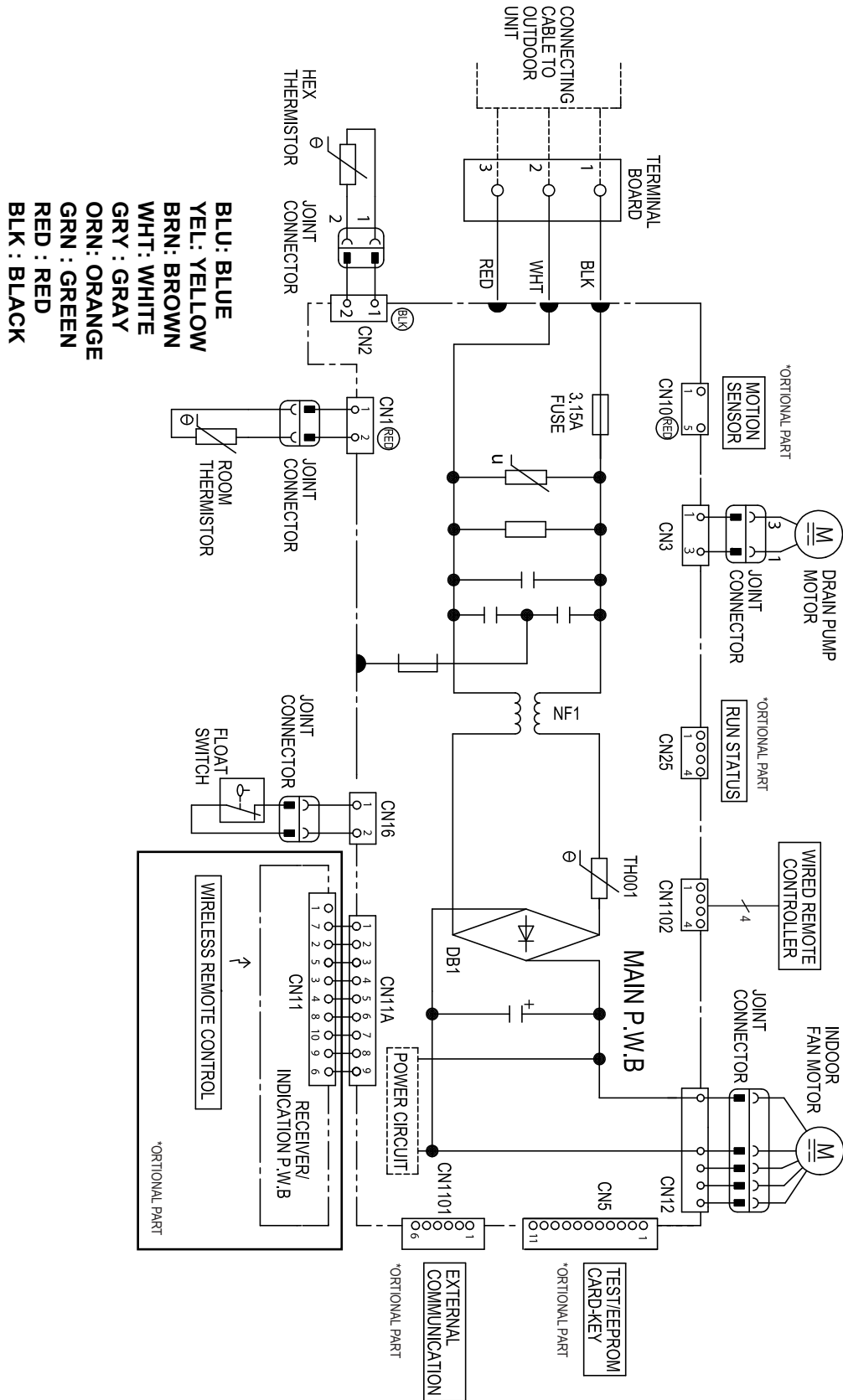

7.2 RAM-S18U2HLAE

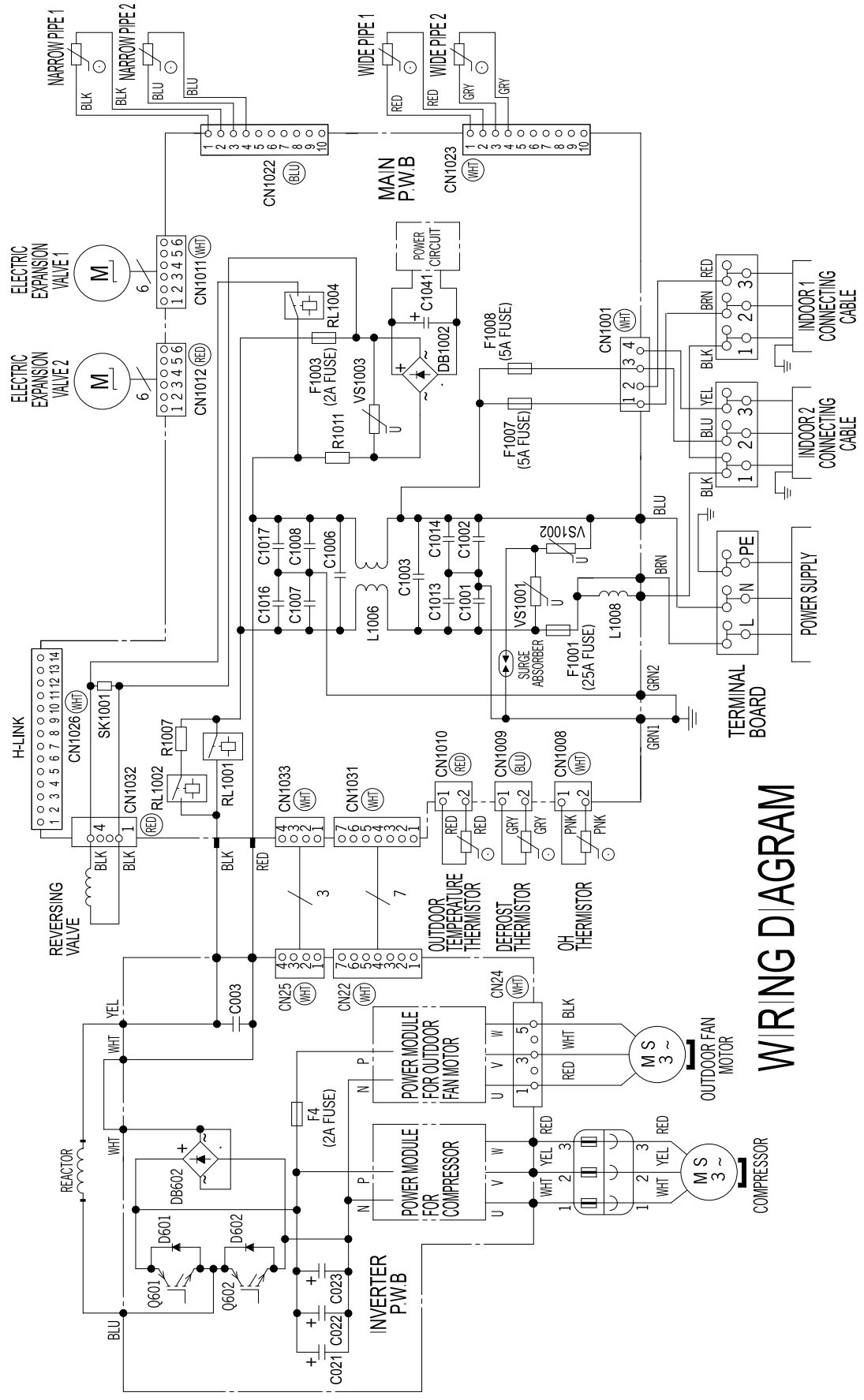

WIRING DIAGRAM

8 REFRIGERANT CYCLE

CONTENT

8	REFRIGERANT CYCLE	8-1
8.1.	MULTIZONE INDOOR UNITS	8-2
8.1.1.	WALL TYPE (RAS-EH07QHLAE, RAS-EH09/12RHLAE)	8-2
8.1.2.	WALL TYPE (RAS-SH07QHLAE, RAS-SH09/12RHLAE)	8-3
8.1.3.	FLOOR TYPE (RAF-SH07/09/12QHLAE)	8-4
8.1.4.	CEILING CASSETTE (RAI- SH07/09/12QHLAE)	8-5
8.1.5.	DUCT TYPE (RAD-SH07/09/12QHLAE)	8-6
8.2.	MULTIZONE OUTDOOR UNITS (RAM-S18U2HLAE)	8-7

8.1. MULTIZONE INDOOR UNITS

8.1.1. WALL TYPE: RAS-EH07QHLAE, RAS-EH09/12RHLAE

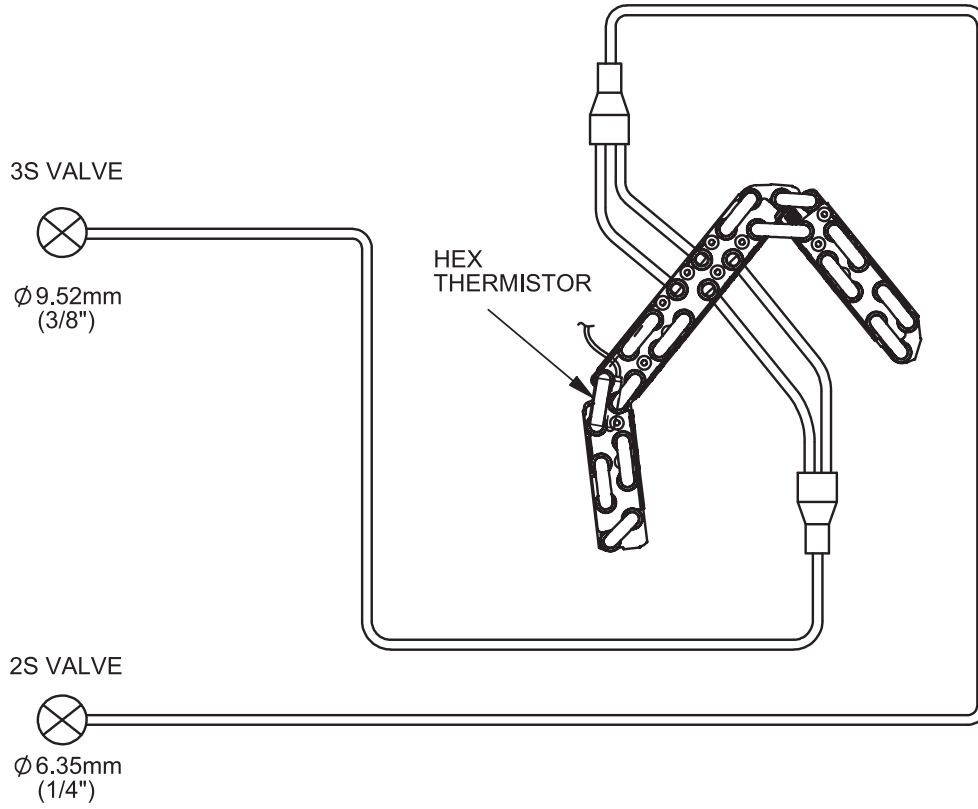

8.1.2. WALL TYPE: RAS-SH07QHLAE, RAS-SH09/12RHLAE

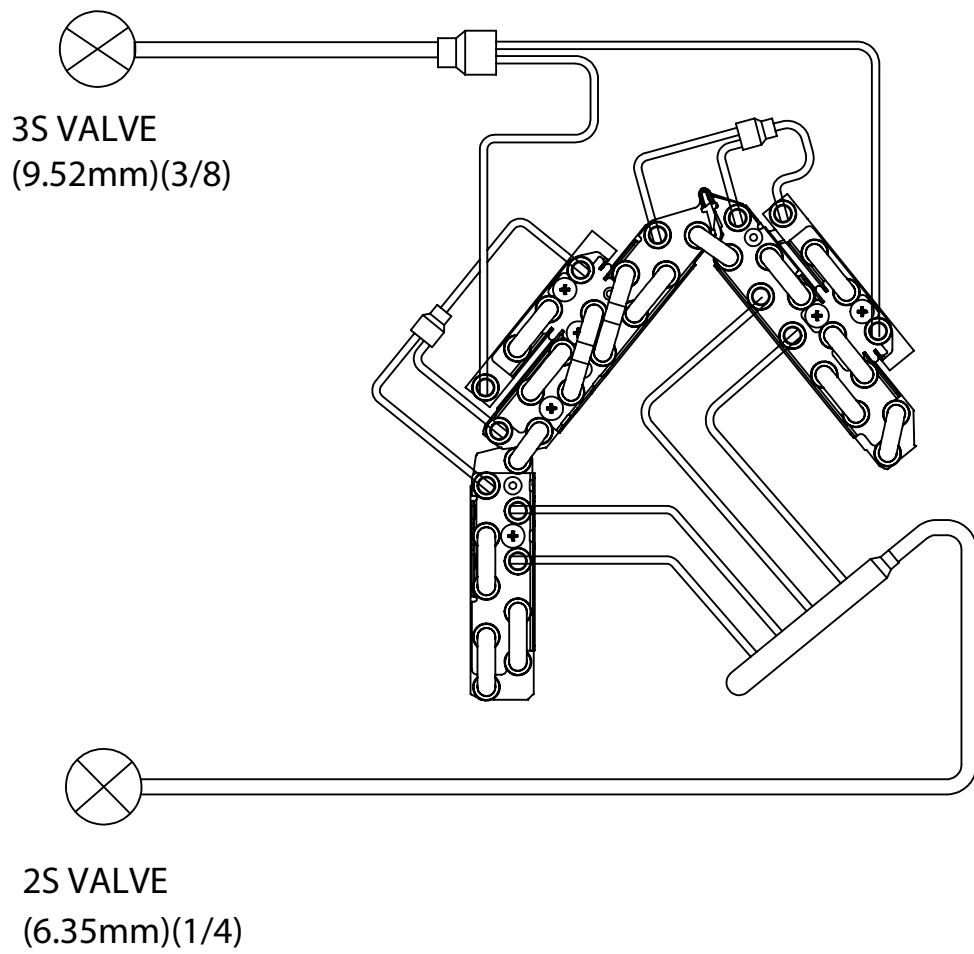

8.1.3. FLOOR TYPE: RAF-SH07QHLAE, RAF-SH09QHLAE, RAF-SH12QHLAE

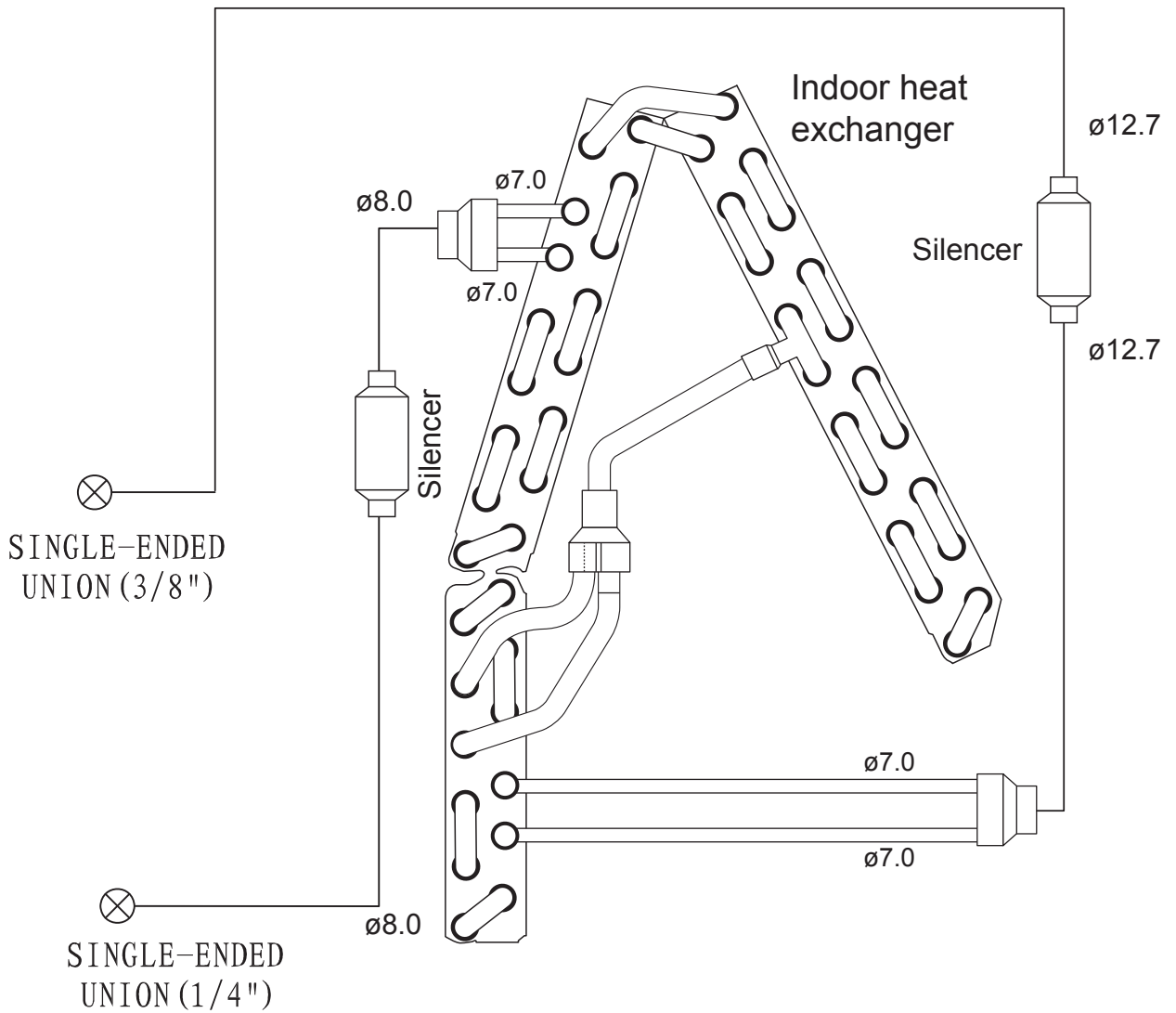

8.1.4. CEILING CASSETTE: RAI-SH07QHLAE, RAI-SH09QHLAE,RAI-SH12QHLAE

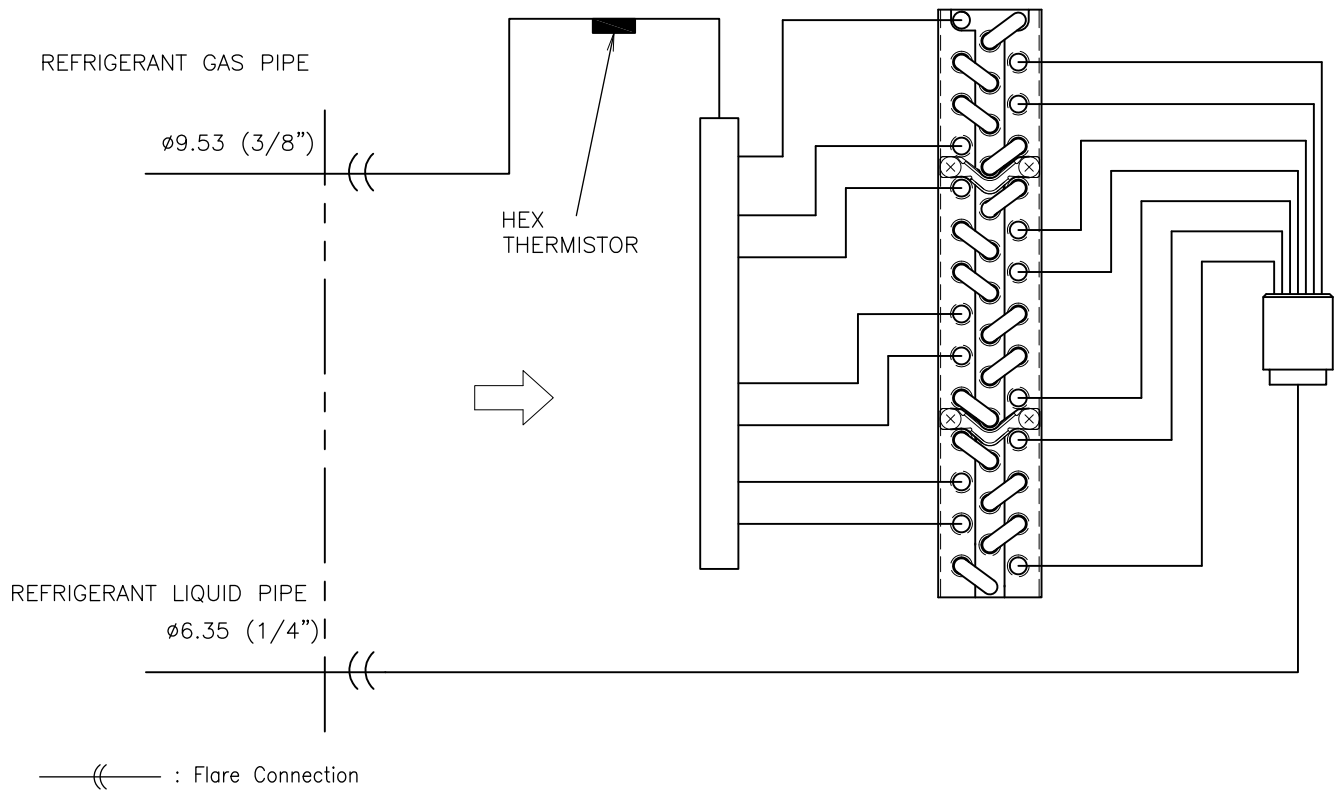

8.1.5. DUCT TYPE: RAD-SH07QHLAE, RAD-SH09QHLAE, RAD-SH12QHLAE

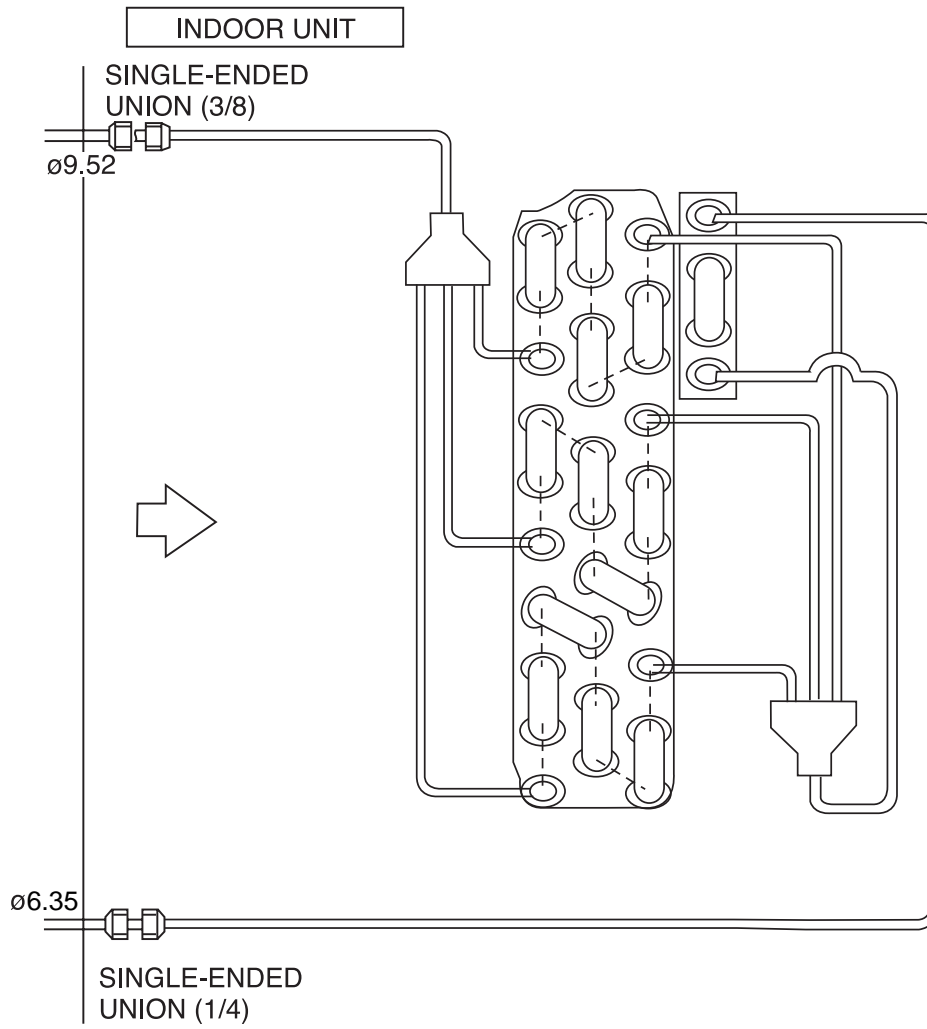

8.2 3 ROOMS MULTIZONE: RAM-S18U2HLAE

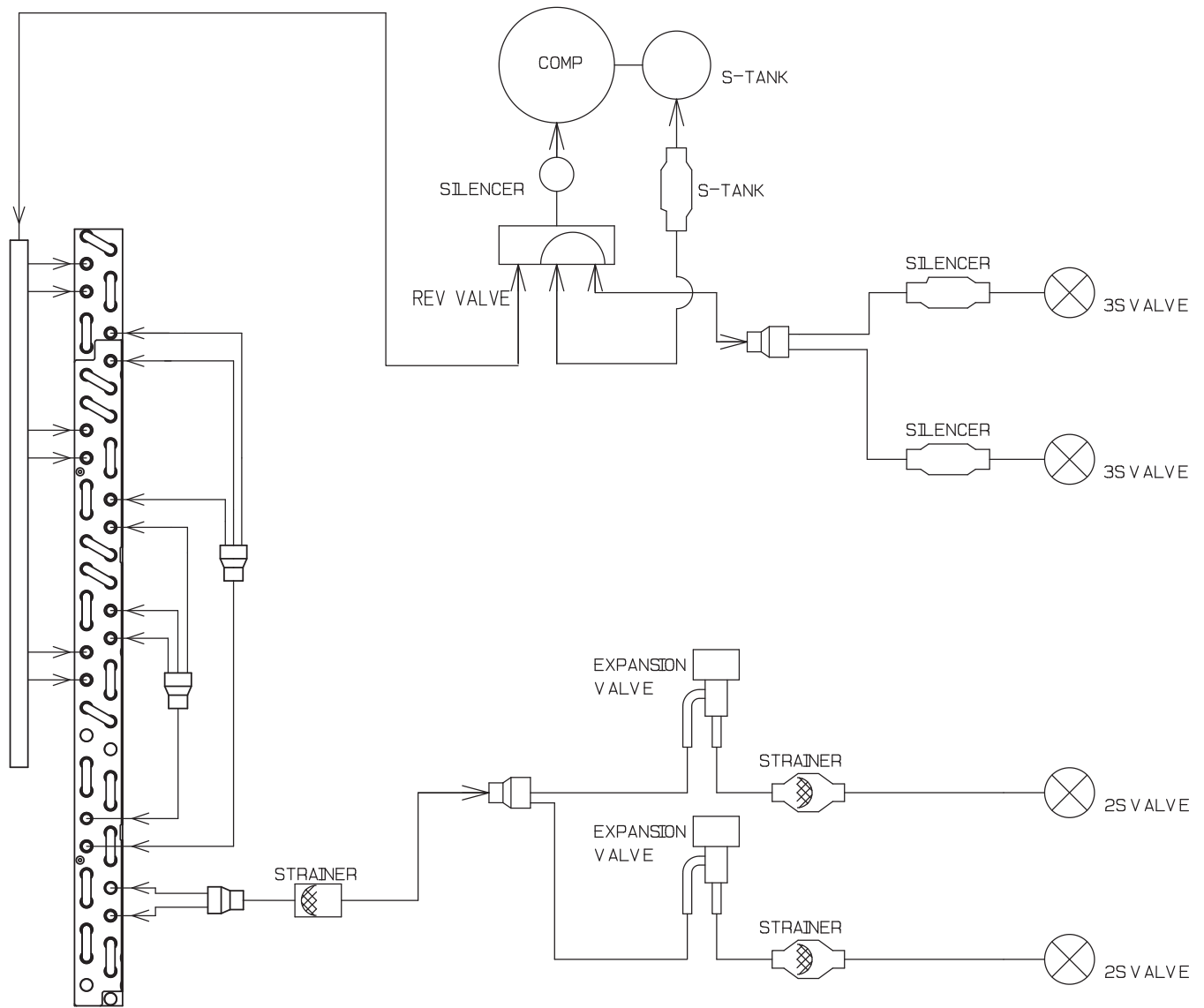

9 CONTROL AND FUNCTION







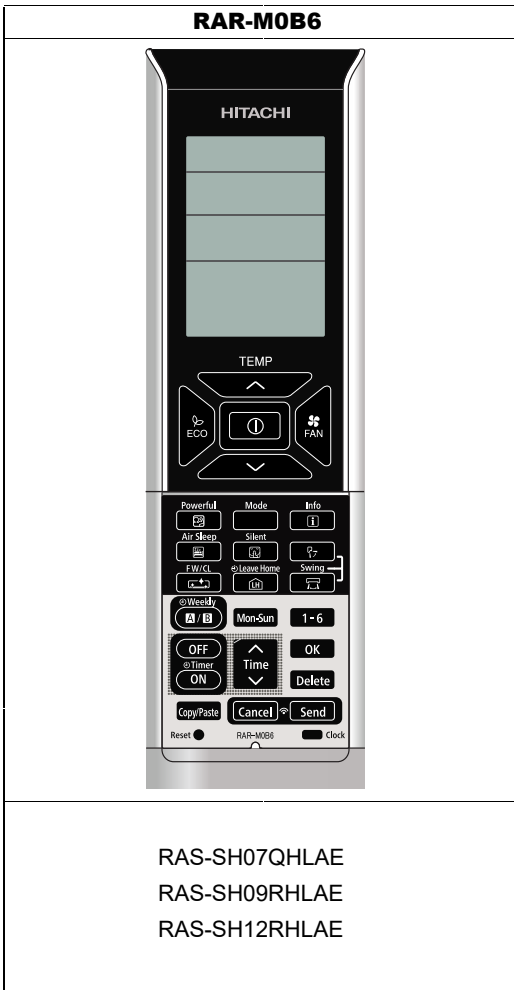

CONTENTS







9	CONTROL AND FUNCTION _____	9-1
9.1.	WIRELESS REMOTE CONTROL FUNCTION _____	9-2
9.1.1.	RAR-M0B3, RAR-M0B4, RAR-M0B5 AND RAR-M0B6 _____	9-2
9.2.	SHIFT VALUE _____	9-3
9.3.	OPERATION LOCK _____	9-5
9.4.	SETTING THE PREVENTION OF MUTUAL INTERFERENCE _____	9-6
9.5.	INTERMITTENT FAN SPEED SETTING _____	9-6
9.6.	FAN SPEED SETTING IN THERMO OFF IN COOLING _____	9-7
9.7.	ERROR CODE INFORMATION _____	9-8
9.8.	ADDITIONAL FUNCTION VIA DIP-SWITCH SETTINGS _____	9-10
9.8.1.	AUTO RESTART FUNCTION _____	9-10
9.8.2.	HEATING/COOLING ONLY MODE SELECTION _____	9-10
9.9.	WIRELESS REMOTE CONTROL FUNCTION _____	9-11
9.10.	SHIFT VALUE _____	9-13
9.11.	DISPLAY OPERATION MODE SETTING _____	9-14
9.12.	HOW TO CHANGE THE INTERMITTENT FAN CONTROL SETTING _____	9-15
9.13.	HOW TO CHANGE THE FAN SPEED IN COOLING MODE DURING THERMO OFF _____	9-16
9.14.	SETTING THE PREVENTION OF MUTUAL INTERFERENCE _____	9-17

9.1 WIRELESS REMOTE CONTROL FUNCTION







RAR-M0B6





BUTTONS	FUNCTION
	MODE Selector Use this button to select the operating mode. Every time you press this button, the mode will change from (AUTO) → (HEAT) → (DEHUMIDIFY) → (COOL) and → (FAN) cyclically.
	FAN SPEED Selector Button This determines the fan speed. Every time you press this button, the airflow rate will change from (AUTO) → (HIGH) → (MED) → (LOW) → (SILENT) (This button allows selection of optimal or preferred fan speed for each operation mode).
	START/STOP button Press this button to start operation. Press it again to stop operation.
	ECO button Use this button to set the ECO mode.
	POWERFUL button Use this button to set the POWERFUL mode.
	SILENT button Use this button to set the SILENT mode.
	INFO button 1) Press this button to display temperature for 10 seconds. 2) Press this button to check monthly power consumption. 3) Press this button to receive the current calendar and clock.
	ECO SLEEP TIMER button Use this button to set the ECO sleep timer.
	AUTO SWING (Vertical) button Controls the angle of the horizontal air deflector.

	AUTO SWING (Horizontal) button Controls the angle of the vertical air deflector.
	LEAVE HOME button Prevent the room temperature from falling too much by setting temperature 50°F~60°F when no one is at home.
	FROST WASH / CLEAN button The dust and dirt adhering to indoor heat exchanger which is the cause of the smell. They are washed away by freezing and thawing of the heat exchanger.
WEEKLY TIMER buttons	
	ON/OFF TIMER button The device will turn on (off) and off (on) at the designated time.
	TIME button Press the button to set starting time of the program
OK	OK button Press the button to save the program. The button shall be pressed everytime after finishing a program setting.
Delete	DELETE button 1) Press the button to delete the selected program. 2) Press the button for about 10 seconds by directing the remote controller towards the indoor unit while Mode A or B display blinks, programs for Mode A or B will be deleted both from the indoor unit and the remote controller after the beep sound from the indoor unit.
Mon-Sun	DAY button Select the desired day of the week.
1 - 6	PROGRAM NO. button Press this button to select a program number.
Cancel	CANCEL 1) Press the button to cancel the current setting process on the screen. 2) Press the button by directing the remote controller towards the indoor unit, then weekly timer setting will be canceled from indoor unit after the beep sound from the indoor unit. The program setting remains in the remote controller.
Send	SEND button Press the button for about 3 seconds by directing the remote controller towards the indoor unit after finishing the program setting. Timer lamp on the indoor unit will blink rapidly and after the beep sound from indoor unit, TIMER lamp will light up.
 Clock	CLOCK button Press the button to set calendar and clock.
	WEEKLY TIMER MODE button 1) Select Mode A or Mode B. 2 modes can be set and stored as a weekly timer. 2) By pressing the button longer than 3 seconds, program setting screen will appear.

9.2 SHIFT VALUE

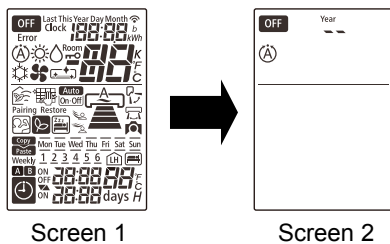
- Press and hold  (START/STOP) button and  (ON) button.
- Press  [RESET] button on the same time. Release  [RESET] button only, then release  (START/STOP) and  (ON) button once Screen 1 appears.



- Press the  (MODE) button to display  fan mode (Screen 3).

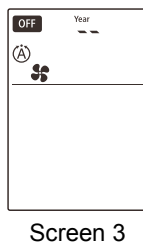

4. Press  (START/STOP) and Screen 4 appear.

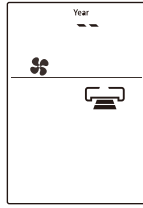

Screen 4



5. Select  (FAN SPEED) button to choose Heating Shift or Cooling Shift Mode (Screen 5).

By setting fan speed to HIGH  or MED  , it will go to Cooling Shift mode.

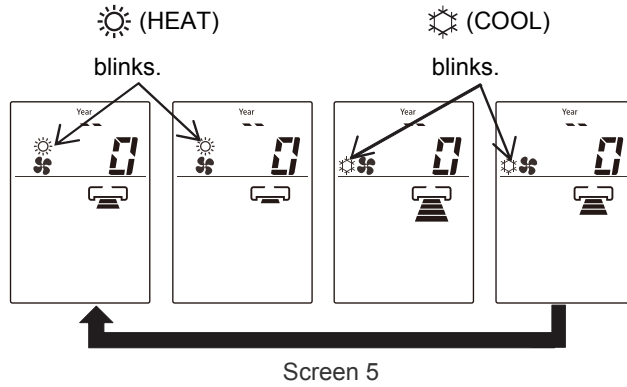
By setting fan speed to LOW  or SILENT  , it will go to Heating Shift mode.



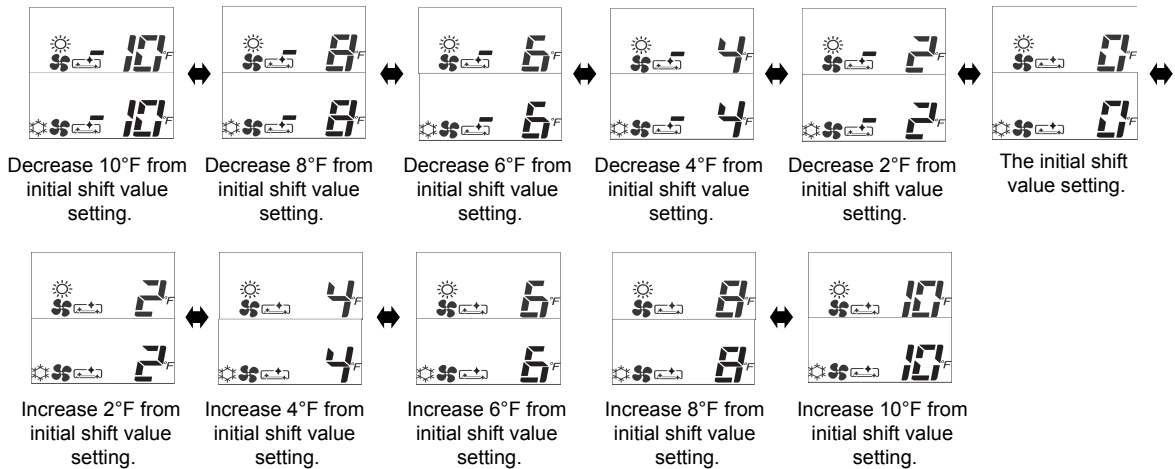

Screen 5

6. Press the Temperature button ( or ) to adjust the shift value.







NOTE:

1. There are total of 11 shift values ranging from -10 to 10.
2. The displayed shift value,  (HEAT) and  (COOL) symbol on the remote controller display will disappear after 10 seconds
3. The changed shift value will remain unchanged after turned off the power.
4. If "0" is displayed on the remote controller display, it indicates the shift value is now at the initial setting.

9.3 OPERATION LOCK

1. HEATING MODE

- a) Press and hold  (ECO) and  (POWERFUL) buttons, press  (RESET) button on the same time. Release  (RESET) button only when Screen 1 appear, then release  (ECO) button and  (POWERFUL) button.

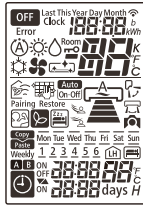

Screen 1



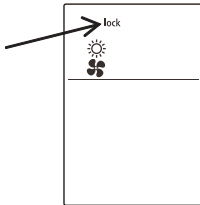

- b) Wait until only Screen 2 appear.



Screen 2

- c) The heating mode operation is locked.
 d) To unlock HEATING mode, repeat step (a). After all operations mode symbols displayed for 10 seconds, the operation mode symbol before cancellation will be display. The heating mode operation is unlocked.

2. COOLING AND DEHUMIDIFYING MODE

- a) Press and hold  (ECO) and  (SILENT) buttons for at least 5 seconds when the remote controller is OFF.
 b) Wait until only  and  displayed on the screen. The cooling and dehumidifying modes operation is locked.
 c) To unlock HEATING mode, repeat step (a). After all operations mode symbols displayed for 10 seconds, the operation mode symbol before cancellation will be display. The cooling and dehumidifying mode operation is unlocked.

9.4 SETTING THE PREVENTION OF MUTUAL INTERFERENCE

1. Please ensure the other indoor unit is OFF.
2. Press **1-6** (PROGRAM NO.) button, **ON** (ON TIMER) button and **Reset** (RESET) button simultaneously. The remote controller will display Screen 1 and followed by Screen 2. The indoor unit beeps to indicate that it has just received the signal from remote controller.

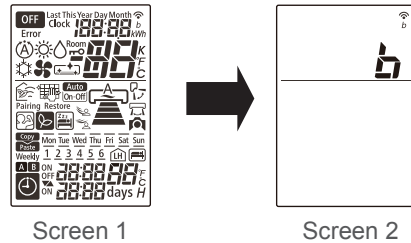

NOTE:

If indoor unit still not receive the correct signal from the correct remote controller, setting shall be made again. By setting again for the 2nd time, the signal address will change from B to A, then repeat again for the 3rd time.

9.5 INTERMITTENT FAN SPEED SETTING

The intermittent fan control during thermo off in Heating Mode can be changed by the remote controller. (This procedure should be done only by service personnel.) It is possible to select from 3 patterns.

PROCEDURE

1. Press **START/STOP** button, **Mon-Sun** (Mon-Sun) button and press **Reset** (RESET) button simultaneously. Release **Reset** (RESET) button only and make sure that all marks on the remote controller display are indicated, then release **START/STOP** button and **Mon-Sun** (Mon-Sun) button. Remote controller now enters "Intermittent Fan Control Change Mode".

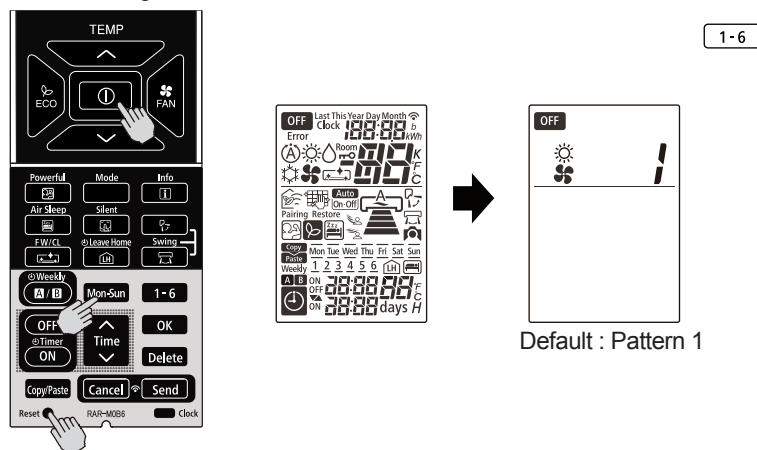

2. Press [ROOM TEMPERATURE setting] [**UP**]/[**DOWN**] buttons. (The intermittent pattern changed with indoor unit beep sound.)

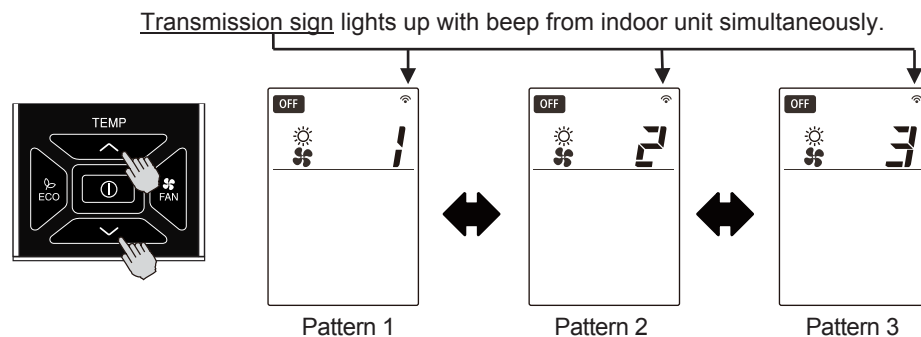

	Pattern 1	Pattern 2	Pattern 3
Single Model	Continuous	30sec ON / 210sec OFF repeatedly	50sec ON / 190sec OFF repeatedly
Multi Model	30sec ON / 210sec OFF repeatedly	50sec ON / 190sec OFF repeatedly	Continuous



NOTE :

- (1) The indication of the selected intermittent pattern will disappear after 10 seconds.
- (2) The selected intermittent pattern will remain unchanged after the unit is turned off.

9.6 FAN SPEED SETTING IN THERMO OFF IN COOLING

The fan speed in Cooling Mode during thermo off can be changed by the remote controller.
 (This procedure shall be implemented strictly by service personnel only.)
 It is possible to return it to the default setting.

PROCEDURE

Press  [POWERFUL] button and  [TIME ^ (UP)] button simultaneously for about 5 seconds when the remote controller is OFF.

Transmission sign lights up with beep from indoor unit simultaneously.

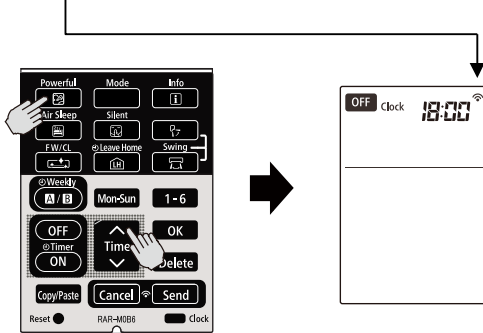



- Beep sound pattern :
- 1) Default setting : Short beep
 - 2) Changed setting : Double beep

	Fan speed during thermo off
Default Setting	Ultra low
Changed Setting	Set fan speed (When auto fan speed is set, the fan speed is low)

NOTE :

- (1) The selected fan speed will remain unchanged after the unit is turned off.
- (2) If Timer reservation has been set, it will be canceled.
- (3) During time setting and timer setting, this operation cannot be set.

9.7 ERROR CODE INFORMATION

1. In case failure occurs to the air conditioner, by pressing  (INFO) button, an error code will be displayed.
2. Direct the remote controller towards the receiver of indoor unit (within 2 meters in front of indoor unit) and press  (INFO) button.
3. Wait for 2 seconds for signal transmission and the error code will be displayed.

	TIMER LAMP BLINKING	LD1351 BLINKING	CODE	MEANING
INDOOR	-	-	000 00	Normal
	1 time		001 00	Refrigerant cycle fault
	2 times	-	-	Outdoor unit is under forced operation
	3 times	-	003 00	Communication error between indoor and outdoor units
	9 times	-	009 00	Indoor thermistor
	10 times	-	010 00	Abnormal rotating numbers
	12 times	-	012 00	Outdoor interface error
	13 times	-	013 00	IC401 data reading error
OUTDOOR	4 times	2 times	002 01	Peak current cut
	4 times	3 times	003 01	Compressor abnormal low speed rotation
	4 times	4 times	004 01	Compressor switching failure
	4 times	5 times	005 01	Overload lower limit cut
	4 times	6 times	006 01	OH thermistor temperature rise
	4 times	7 times	007 01	Abnormal outdoor thermistor
	4 times	8 times	008 01	Communication error between micon
	4 times	9 times	009 01	Indoor type mis-matched
	4 times	10 times	010 01	Abnormal power source
	4 times	11 times	011 01	Fan stop for strong wind
	4 times	12 times	012 01	Fan motor fault
	4 times	13 times	013 01	EEPROM reading error
	4 times	14 times	014 01	Active converter defective
	4 times	15 times	015 01	Abnormal PWB circuit

	TIMER LAMP BLINKING	LD1351 Lit LD1352 BLINKING	CODE	MEANING
OUTDOOR	4 times	1 times	071 01	Overheat thermostat
	4 times	2 times	072 01	Defrost thermostat
	4 times	3 times	073 01	Outdoor temperature thermostat
	4 times	4 times	074 01	Narrow pipe thermostat (indoor 1)
	4 times	5 times	075 01	Wide pipe thermostat (indoor 1)
	4 times	6 times	076 01	Narrow pipe thermostat (indoor 2)
	4 times	7 times	077 01	Wide pipe thermostat (indoor 2)
	4 times	8 times	078 01	Narrow pipe thermostat (indoor 3)
	4 times	9 times	079 01	Wide pipe thermostat (indoor 3)
	4 times	10 times	080 01	Narrow pipe thermostat (indoor 4)
	4 times	11 times	081 01	Wide pipe thermostat (indoor 4)
	4 times	12 times	082 01	Narrow pipe thermostat (indoor 5)
	4 times	13 times	083 01	Wide pipe thermostat (indoor 5)

9.8 ADDITIONAL FUNCTION VIA DIP-SWITCH SETTINGS

A new DIP Switch is available on the PWBs of the indoor unit that provide additional functions via the settings on the switches.

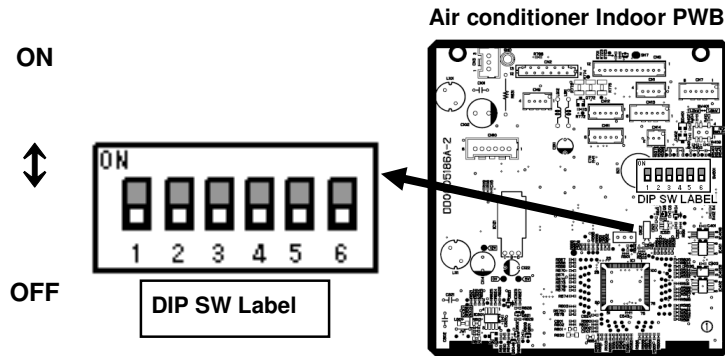

Pin No.	Function	Switch Position / Setting					
		OFF	Enable	ON	Disable		
1	AUTO RESTART function	OFF	Enable	ON	Disable		
2	DRY CONTACT function	OFF	Disable	ON	Enable		
3	DRY CONTACT Logic Select	OFF	HI Input Active	ON	LO Input Active		
4	HEATING / COOLING ONLY MODE SELECT	OFF	NORMAL (HEAT AND COOL)	OFF	HEATING ONLY	ON	COOLING ONLY
5		OFF		ON		OFF	
6	REMOCON ID SELECT ❖1	OFF	SELECT ID A	ON	SELECT ID B		

NOTE:

- ❖1 The setting of pin no. 6 is disabled for this model. Please refer to **9.4 SETTING THE PREVENTION OF MUTUAL INTERFERENCE**.

9.8.1 AUTO RESTART FUNCTION

The AUTO RESTART function can be enabled or disabled by setting Pin No. 1 on the DIP SWITCH above to the ON or OFF position accordingly.



9.8.2 HEATING/COOLING ONLY MODE SELECTION









When this function is enabled, the operation mode could be locked to either Heating Only (Heating or Fan) or Cooling Only (Cooling, Fan or Dehumidifying) by setting the Pin No. 4 and 5 accordingly.



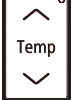



LOCKED MODE	REMARKS
HEATING ONLY	Unit will not enter into Cooling mode although cooling mode is selected using the remote controller.
COOLING ONLY	Unit will not enter into Heating mode although heating mode is selected using the remote controller.

9.9 WIRELESS REMOTE CONTROL FUNCTION

RAR-M0B3、RAR-M0B4、RAR-M0B5

RAR-M0B3	RAR-M0B4	RAR-M0B5
		
<p>RAF-SH07QLAE RAI-SH07QLAE RAF-SH09QLAE RAI-SH09QLAE RAF-SH12QLAE RAI-SH12QLAE</p>	<p>RAD-SH07QLAE RAD-SH09QLAE RAD-SH12QLAE</p>	<p>RAS-EH07QLAE RAS-EH09RLAE RAS-EH12RHLAE</p>

BUTTONS	FUNCTION
	<p>MODE selector Button Use this button to select the operating mode. Every time you press this button, the mode will change from (A) (AUTO) → ☀ (HEAT) → 💧 (DEHUMIDIFY) → ❄ (COOL) and(FAN) → 🌀 cyclically.</p>
	<p>ECO Button Use this button to set the ECO mode.</p>
	<p>TEMPERATURE Button Room temperature setting. Value will change quicker when keep pressing.</p>
	<p>ON/OFF Button Press this button to start operation. Press it again to stop operation.</p>
	<p>FAN SPEED Button Select the fan speed for cooling and heating mode.</p>
	<p>TIMER OFF Button Select the turn OFF time.</p>
	<p>TIMER ON Button Select the turn ON time.</p>
	<p>POWERFUL Button Press this button to start powerful operation.</p>

 <p>F.W/CL</p>	FROST WASH/CLEAN Button The dust and dirt adhering to indoor heat exchanger which is the cause of the smell. They are washed away by freezing and thawing of the heat exchanger.
 <p>Clean</p>	ONE TOUCH CLEAN button Drying indoor heat exchanger after cooling operation to prevent mildew.
 <p>UP/DOWN</p>	UP/DOWN Button Control the angle of the horizontal air deflector.
 <p>LEAVE HOME</p>	LEAVE HOME Button Prevent the room temperature from falling too much by setting temperature 10°C~16°C when no one is at home.
 <p>SILENT</p>	SILENT button Use this button to set the SILENT mode.
 <p>ECO SLEEP TIMER</p>	ECO SLEEP TIMER button Use this button to set the ECO sleep timer.

For more information, please refer to the operation manual.

9.10. SHIFT VALUE

1. While pressing and holding (ON/OFF) button and button, press [RESET] button on the same. Release [RESET] button only and make sure that all marks on the remote controller display are indicated then release the (ON/OFF) button and button. Remote controller now enters "Shift Value Change Mode".
2. Press the (MODE) selector button so that the display indicates (FAN) mode.
3. Press the (ON/OFF) button and FAN operation will be started.

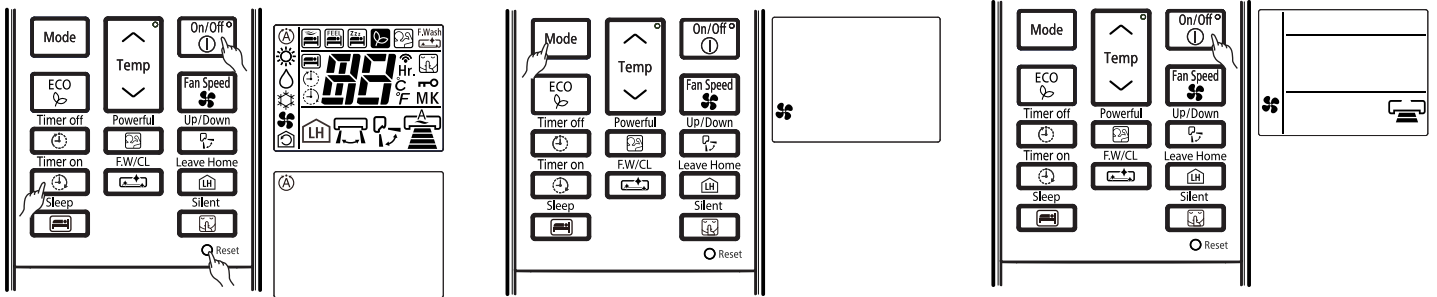

4. Set the FAN SPEED with the (FAN SPEED) button according to the following FAN speed setting in order to choose the desired operation mode that is required for shift value temperature modification.
 - To change the shift value for COOLING mode operation, select either (HIGH) or (MED) FAN SPEED.
 - To change the shift value for HEATING mode operation, select either (LOW) or (SILENT) FAN SPEED.
5. Press the (TEMP \downarrow or \uparrow) button to change the shift value. (The shift value changed with device producing beep sound.)

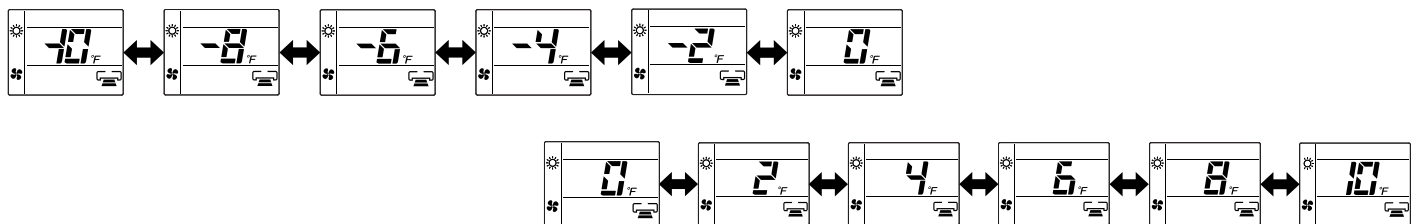
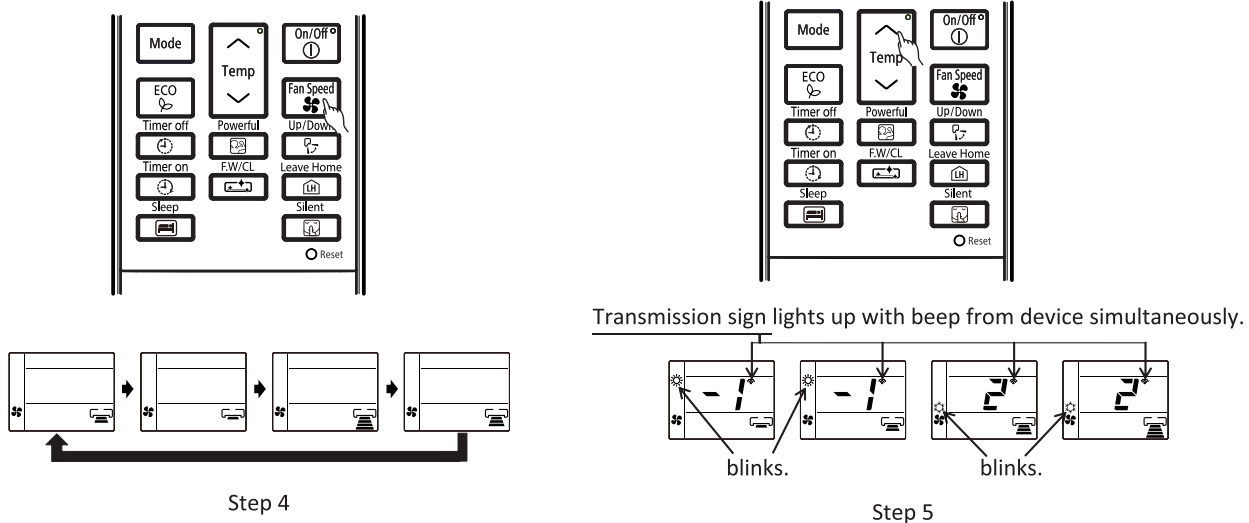









NOTE :

1. The displayed shift value, (HEAT) and (CO OL) symbol on the remote controller display will disappear after 10 seconds.
2. The changed shift value will remain unchanged after turned off the power.
3. If "0" is displayed on the remote controller display, it indicates the shift value is now at the initial setting .



9.11. DISPLAY OPERATION MODE SETTING

For operating indoor unit independently (without outdoor unit connection), remote controller must be set according to below procedures before send the signal to the indoor unit. New communication format between indoor and outdoor is required to communicate with outdoor unit.

PROCEDURE

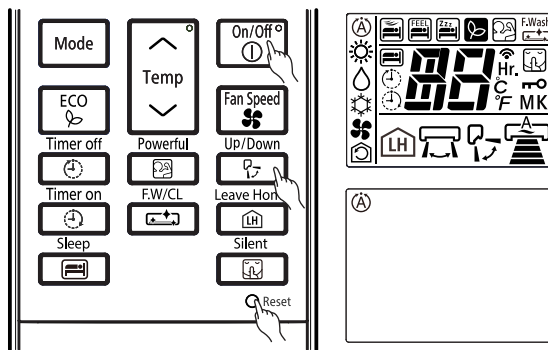
1. While pressing and holding  (ON/OFF) button and  (UP/DOWN) button, press  (RESET) button on the same time. Release  (RESET) button only and make sure that all marks on the LCD display are indicated, then release the  (ON/OFF) button and  (UP/DOWN) button. Remote controller now enters "DISPLAY OPERATION MODE" for the indoor unit to run independently. Please ensure that when pressing  (FAN SPEED) button, "" will be blinking.



2. Press the  (MODE) selector button to choose the desired operation mode.
3. Press  (ON/OFF) button.

Then, the indoor unit will start to operate independently according to the selected operation mode.

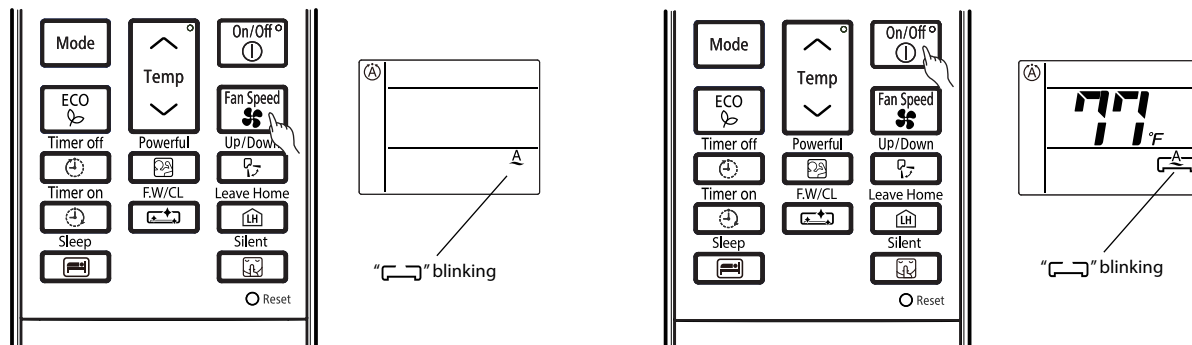

NOTE :

- (1) During "DISPLAY OPERATION MODE", "" blinks on LCD of remote controller.
- (2) When operation stops, "DISPLAY OPERATION MODE" is canceled.



9.12. HOW TO CHANGE THE INTERMITTENT FAN CONTROL SETTING

The intermittent fan control during thermo off in Heating mode can be changed by the remote controller.



(The procedure should be done only by service personnel.)

It is possible to select from 3 patterns.

PROCEDURE

Press  (POWERFUL) button,  (FAN SPEED) button and press  [RESET] button simultaneously.

Release  [RESET] button only and make sure that all marks on the remote controller display are indicated, then release

 (POWERFUL) button and  (FAN SPEED) button.

Remote controller now enters "Intermittent Fan Control Change Mode".

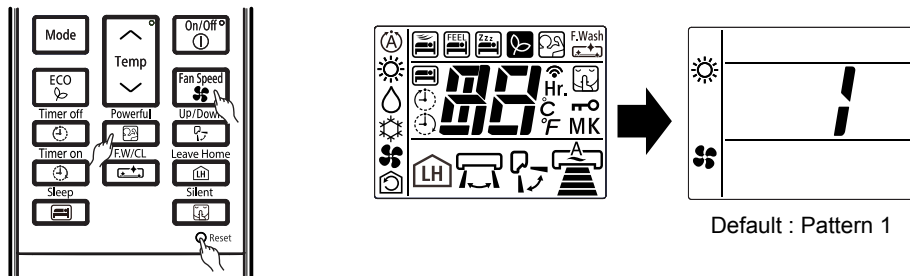

Press [ROOM TEMPERATURE setting] [^ (UP) / v (DOWN)] button.

(The intermittent pattern changed with indoor unit beep sound)

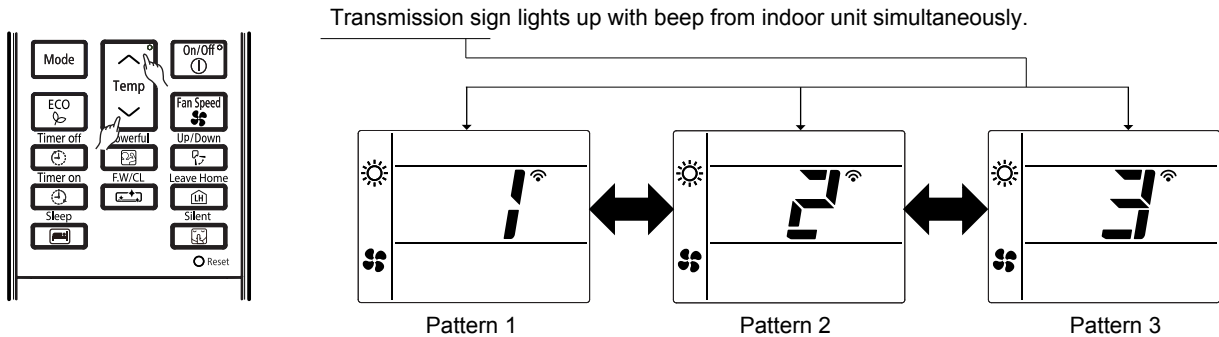

	Pattern 1	Pattern 2	Pattern 3
Single model	Continuous	30sec ON / 210sec OFF repeatedly	50sec ON / 190sec OFF repeatedly
Multi	30sec ON / 210sec OFF repeatedly	50sec ON / 190sec OFF repeatedly	Continuous



NOTE :

- (1) The indication of the selected intermittent pattern will disappear after 10 seconds.
- (2) The selected intermittent pattern will remain unchanged after the unit is turned off.

9.13. HOW TO CHANGE THE FAN SPEED IN COOLING MODE DURING THERMO OFF

The fan speed in Cooling Mode during thermo off can be changed by the remote controller.
 (This procedure shall be implemented strictly by service personnel only.)
 It is possible to return it to the default setting.

PROCEDURE

Press  [POWERFUL] button and  [ECO] button simultaneously for about 5 seconds when the remote controller is OFF.

Transmission sign lights up with beep from indoor unit simultaneously.

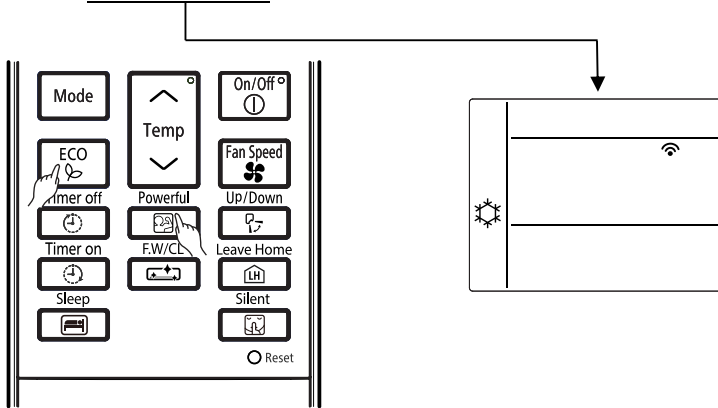

- Beep sound pattern :
- 1) Default setting : Short beep
 - 2) Changed setting : Double beep

	Fan speed during thermo off
Default Setting	Ultra low
Changed Setting	Set fan speed (When auto fan speed is set, the fan speed is low)

NOTE :

- (1) The selected fan speed will remain unchanged after the unit is turned off.
- (2) If Timer reservation has been set, it will be canceled.
- (3) During time setting and timer setting, this operation cannot be set.

9.14. SETTING THE PREVENTION OF MUTUAL INTERFERENCE

a.) Other indoor circuit breakers should be disconnected.



- b.) Remove the back cover of the remote control.
- c.) Cut the jumper as shown below.
- d.) Press "Reset" button after installing the battery.
- e.) Corresponding to the room electrical box dial code 6 to dial on.

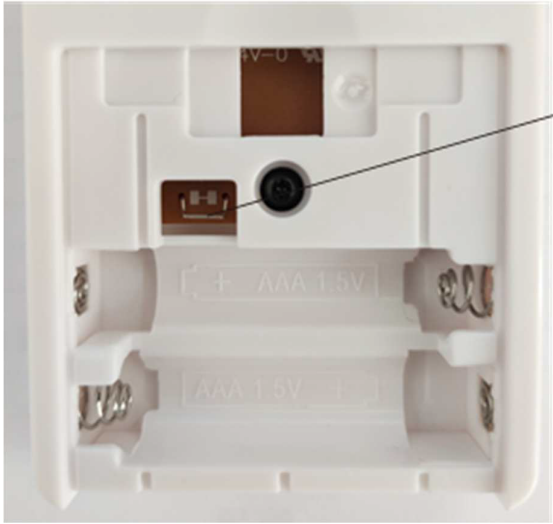

Cut (Attention: Remove the battery before cutting. Do not cut with electricity).



f.) Please use the remote control to check the available models of corresponding indoor machines.



10 OPTION LIST











CONTENTS

10	OPTION LIST	10-1
10.1.	WIRED REMOTE CONTROL SPX-RCDA1 AND SPX-RCDB1	10-2
10.1.1.	SHIFT VALUE	10-3
10.1.2.	ERROR CODE INFORMATION	10-4
10.2.	WIRED REMOTE CONTROL SPX-WKT4	10-7
10.2.1.	SERVICE MENU OPERATION	10-8
10.2.1.1.	SERVICE MENU	10-8
10.2.1.2.	DISPLAY ROOM TEMPERATURE	10-9
10.2.1.3.	CONTACT INFORMATION REGISTRATION	10-9
10.2.1.4.	LIMIT OPERATION	10-10
10.2.1.5.	SHIFT CHANGE	10-11
10.2.1.6.	INTERMITTENT FAN CONTROL	10-12
10.2.1.7.	FAN SPEED DURING THERMO OFF	10-13
10.2.1.8.	OPERATION LOCK	10-14
10.2.1.9.	DISPLAY MALFUNCTION	10-15
10.2.1.10.	DISPLAY ALARM HISTORY	10-16
10.2.1.11.	DEFROSTING INHIBIT PERIOD SELECTION	10-17
10.2.1.12.	ECO AUTO OFF	10-18
10.2.1.13.	CLEAN (SERVICE)	10-19
10.2.1.14.	KEY LOCK	10-19
10.2.2.	CHECK MENU OPERATION	10-20
10.2.2.1.	SELF CHECKING	10-20
10.3.	H-LINK ADAPTOR – PSC 6RAD	10-23
10.3.1.	SAFETY SUMMARY	10-23
10.3.2.	INSTALLATION WORK	10-23
10.3.3.	ELECTRICAL WIRING	10-24
10.3.4.	DIP SWITCH SETTING	10-25
10.3.5.	TEST RUN	10-26
10.4.	DRY CONTACT (SPX-WDC2 AND SPX-WDC3) APPLICATION (USING DIP SWITCH)	10-27
10.5.	DISTRIBUTOR – SPX-DST1	10-30
10.6.	REMOTE SENSOR - SPX-RTH1	10-31
10.6.1.	SELECTION OF INSTALLATION POSITION	10-31
10.6.2.	INSTALLATION PROCEDURE	10-31
10.6.3.	WIRING PROCEDURES	10-31



10.1 WIRED REMOTE CONTROL SPX-RCDA1 AND SPX-RCDB1

This controls the operation function and timer setting of the room air conditioner.

SPX-RCDA1	SPX-RCDB1
	
<p>RAD-SH07QHLAE RAD-SH09QHLAE RAD-SH12QHLAE</p>	<p>RAS-EH07QHLAE RAF-SH07QHLAE RAS-EH09RHLAE RAF-SH09QHLAE RAS-EH12RHLAE RAF-SH12QHLAE</p> <p>RAS-SH07QHLAE RAI-SH07QHLAE RAS-SH09RHLAE RAI-SH09QHLAE RAS-SH12RHLAE RAI-SH12QHLAE</p>

BUTTONS	FUNCTION
	<p>MODE Selector Use this button to select the operating mode. Every time you press this button, the mode will change from ☉ (AUTO) → ☀ (HEAT) → ☁ (DEHUMIDIFY) → ❄ (COOL) cyclically.</p>
	<p>FAN SPEED Selector Button This determines the fan speed. Every time you press this button, the airflow rate will change from 🌀 (AUTO) → 🌀 (HIGH) → 🌀 (MED) → 🌀 (LOW) → 🌀 (SILENT) (This button allows selection of optimal or preferred fan speed for each operation mode).</p>
	<p>ON/OFF button Press this button to start operation. Press it again to stop operation.</p>
	<p>SLEEP button Use this button to set the SLEEP timer.</p>
	<p>SET button Timer setting reservation.</p>
	<p>OFF button Select the turn OFF timer.</p>
	<p>ON button Select the turn ON timer.</p>
	<p>CANCEL button Cancel timer reservation.</p>
	<p>AUTO SWING (Vertical) button Controls the angle of the horizontal air deflector.</p>
	<p>ROOM TEMPERATURE setting button</p>

10.1.1 SHIFT VALUE

1. Press and hold ① (ON/OFF) button and  (ON TIMER) button at the same time while giving a single press on the RESET button until remote controller now enter 'Shift value change mode'.
2. Press ① (ON/OFF) button so that the display indicates  (FAN) speed.
3. Select  (FAN SPEED) button to choose Heating Shift or Cooling Shift Mode.

By setting fan speed to HIGH  or MED  , it will go to Cooling Shift mode.

By setting fan speed to LOW  or SILENT  , it will go to Heating Shift mode.











4. Press  (ROOM TEMPERATURE) button to change the shift value (-5°C ~ 0 ~ 5°C).
5. Press ① (ON/OFF) button to end 'Shift value setting mode'.



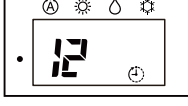





NOTE:





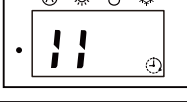
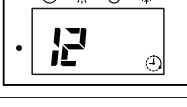
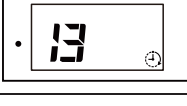

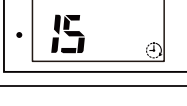

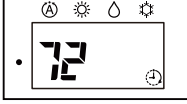

1. There are total of 11 shift values ranging from -5 to 5.
2. The changed shift value will remain unchanged after turned off the power.

10.1.2 ERROR CODE INFORMATION

1. In case failure occurs to the air conditioner, the error code will constantly appear on the wired remote controller display.

	TIMER LAMP BLINKING	LD1351 BLINKING	CODE	MEANING
INDOOR	-	-	-	Normal
	1 time	-		Refrigerant cycle fault
	2 times	-	-	Outdoor unit is under forced operation
	3 times	-		Communication error between indoor and outdoor units
	9 times	-		Indoor thermistor
	10 times	-		Abnormal rotating numbers
	12 times	-		Outdoor interface error
	13 times	-		IC401 data reading error
OUTDOOR	4 times	2 times		Peak current cut
	4 times	3 times		Compressor abnormal low speed rotation
	4 times	4 times		Compressor switching failure
	4 times	5 times		Overload lower limit cut

	TIMER LAMP BLINKING	LD1351 BLINKING	CODE	MEANING
OUTDOOR	4 times	6 times		OH thermistor temperature rise
	4 times	7 times		Abnormal outdoor thermistor
	4 times	8 times		Communication error between micon
	4 times	9 times		Indoor type mis-matched
	4 times	10 times		Abnormal power source
	4 times	11 times		Fan stop for strong wind
	4 times	12 times		Fan motor fault
	4 times	13 times		EEPROM reading error
	4 times	14 times		Active converter defective
	4 times	15 times		Abnormal PWB circuit
		LD1351 Lit LD1352 BLINKING		
	4 times	1 times		Overheat thermostat
	4 times	2 times		Defrost thermostat

	TIMER LAMP BLINKING	LD1351 Lit LD1352 BLINKING	CODE	MEANING
OUTDOOR	4 times	3 times		Outdoor temperature thermostat
	4 times	4 times		Narrow pipe thermostat (indoor 1)
	4 times	5 times		Wide pipe thermostat (indoor 1)
	4 times	6 times		Narrow pipe thermostat (indoor 2)
	4 times	7 times		Wide pipe thermostat (indoor 2)
	4 times	8 times		Narrow pipe thermostat (indoor 3)
	4 times	9 times		Wide pipe thermostat (indoor 3)
	4 times	10 times		Narrow pipe thermostat (indoor 4)
	4 times	11 times		Wide pipe thermostat (indoor 4)
	4 times	12 times		Narrow pipe thermostat (indoor 5)
	4 times	13 times		Wide pipe thermostat (indoor 5)

10.2 WIRED REMOTE CONTROL SPX-WKT4

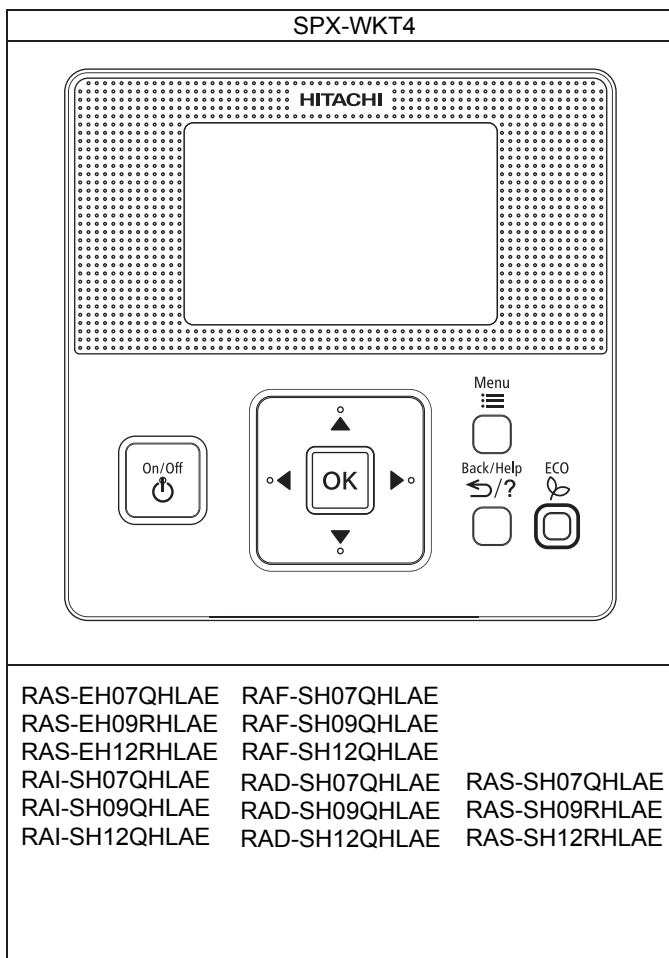

10.2.1 SERVICE MENU OPERATION

10.2.1.1 SERVICE MENU

Various setting functions are displayed in the service menu. This procedure shall be implemented strictly by service personnel only. After implementing this procedure, test run must be performed to ensure that the procedure has been done as intended, without any issues. Refer to the following sections for each function.

NOTE:

☒ : Unable to set

- If the function with "☒" is selected from the menu, "Setting Disabled" will be displayed on the lower screen.
- The image in case of Celsius setting of setting temperature is shown in this manual as the example.

1 Press and hold **Menu** and **Back/Help** simultaneously for at least 3 seconds during the normal mode. The service menu will be displayed.

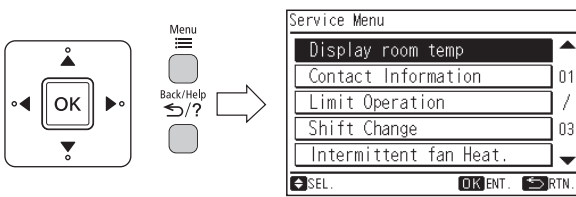

3 Press "**Back/Help**" (return/help) to return to the normal mode.

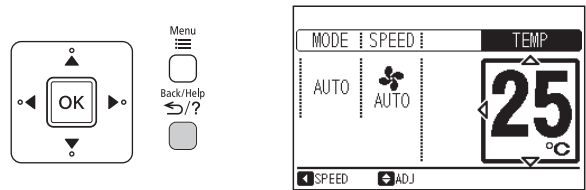

2 Select the "Service Menu" function by pressing "**▲**" or "**▼**" and press "OK". ("☒" will be displayed if the function is not available.)

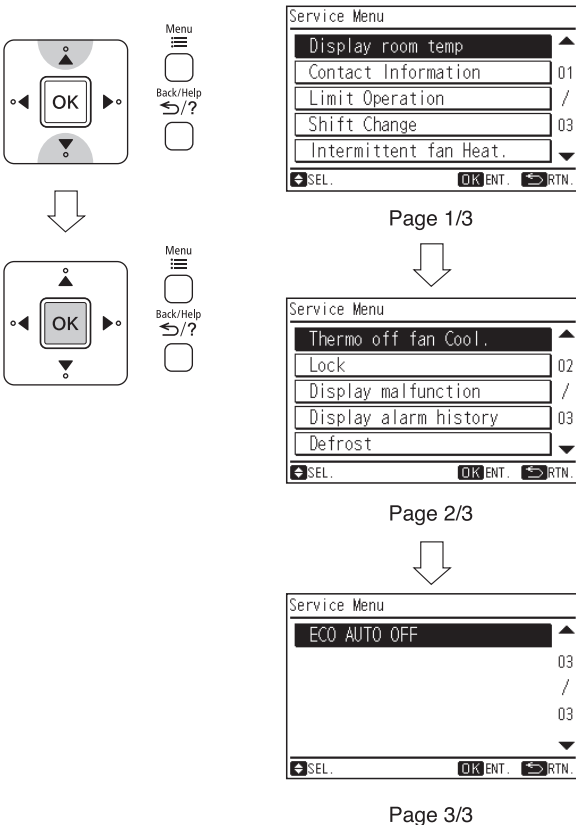

NOTE:

- If the menu screen remains unchanged for approximately 2 hours, the screen will automatically return to the normal mode.

NOTE:

- The "Service Menu" functions vary depending on which is displayed in the stop and in operation, or model-wise.

10.2.1.2 DISPLAY ROOM TEMPERATURE

Room temperature(around remote controller) can be displayed.

- 1 Select "Display room temp" from the service menu and press "OK".
The confirmation screen will be displayed.

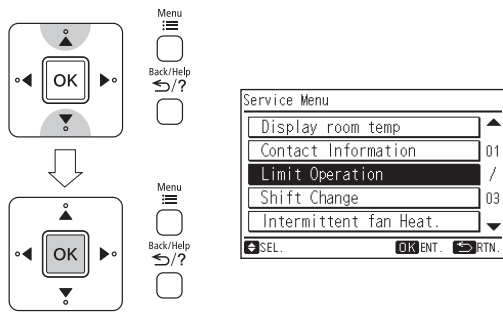

- 2 Select "Yes" by pressing "<" or ">" and press "OK". The setting will be confirmed and the screen will return to the normal mode.

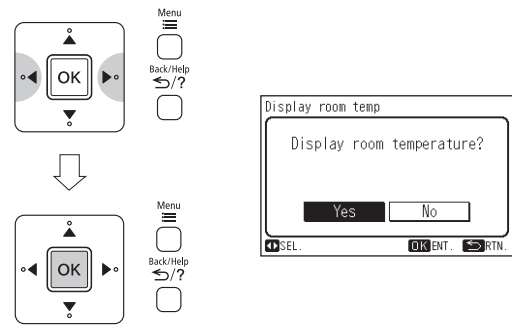

10.2.1.3 CONTACT INFORMATION REGISTRATION

Contact information can be registered from "Contact information".

- 1 Select "Contact information" from the service menu and press "OK". The contact information 1 will be displayed.

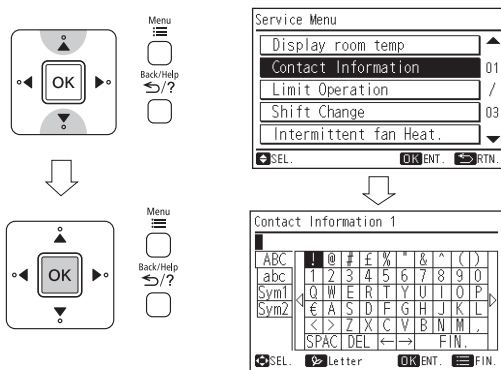

- 5 Select "FIN." and press "OK" (or simply press Menu). "Contact information 2" will be displayed.

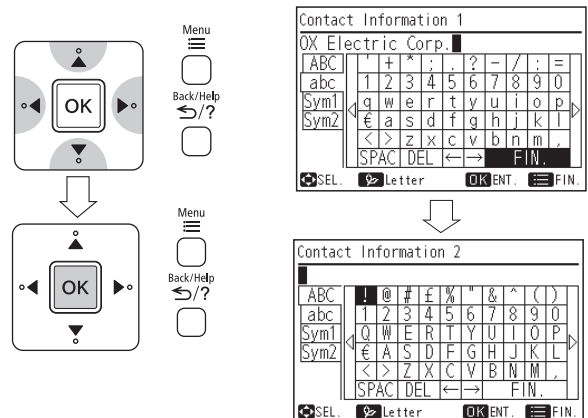

- 2 Press to change font type.
- 3 Press "< >" to select letter.
- 4 Press "OK" to confirm the letter. (Max.: 28 letters)

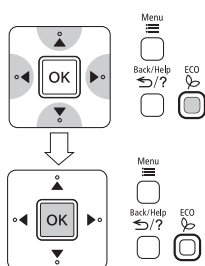

- 6 Repeat (3)-(5) to register the contact information 2.
Select "FIN." and press "OK", the confirmation screen will be displayed.
(Also press Menu and the confirmation screen will be displayed.)

- 7 Select "Yes" and press "OK". The service menu will be displayed after setting is confirmed.
If "No" is pressed, the screen will return to (3).

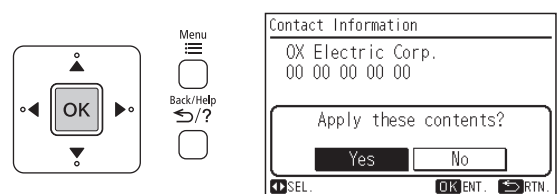
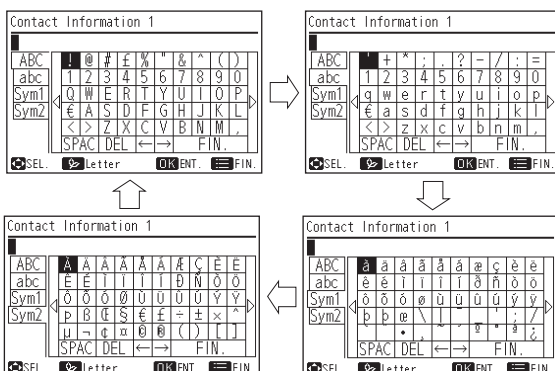

10.2.1.4 LIMIT OPERATION

Setting temperature range can be changed.

- 1 Select "Limit Operation" from the service menu and press "OK".
The limit operation setting will be displayed.

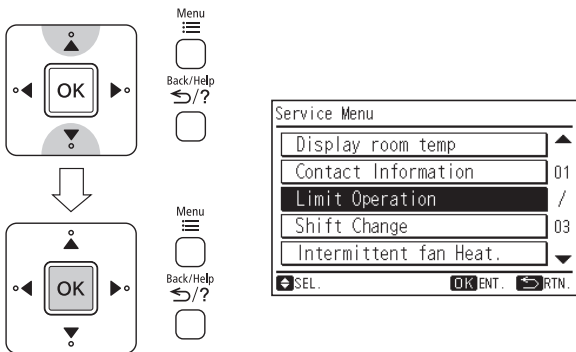

- 2 Press "△" or "▽" to select the setting items. The setting items are displayed "Limit Setting", "Cool-Dry", "Heat" and "Auto".

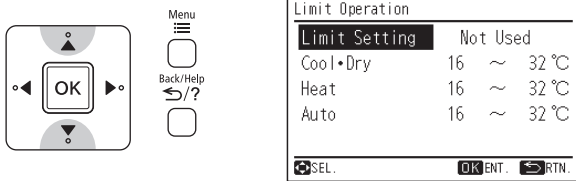

- 3 Press "◀" or "▶" to set each setting content for the selected item. When "Limit Setting" is selected, the setting contents are switched in order of "Not Used" ↔ "Used" by pressing "△" or "▽". When "Cool-Dry" or "Heat" or "Auto" is selected, the setting temperature (lower limit or upper limit) can be set every 1°C (1°F) by pressing "△" or "▽".

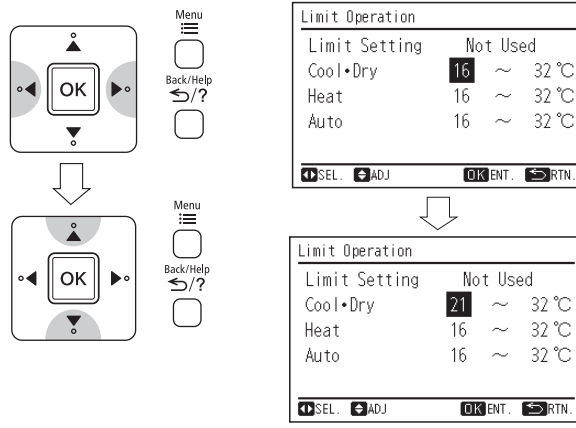

- 4 Press "OK" to finish the limit operation setting. The confirmation screen will be displayed.

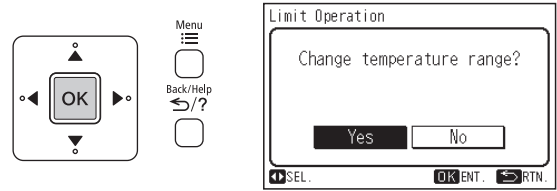

- 5 Select "Yes" by pressing "◀" or "▶" and press "OK".
The setting will be confirmed and the screen will return to the service menu.

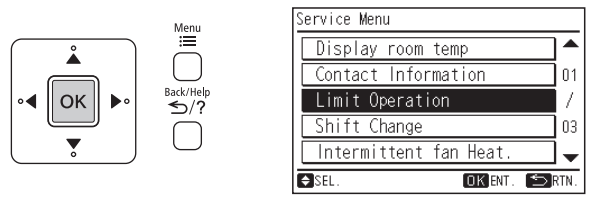

- 6 Press "Back/Help" (return/help) to return to the normal mode.

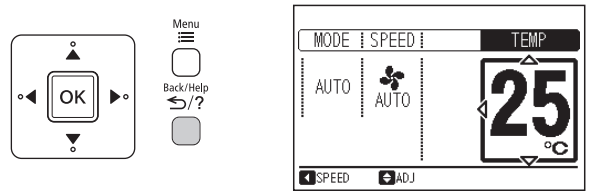

NOTE:

- The limit operation setting will remain unchanged after the unit is turned off.

10.2.1.5 SHIFT CHANGE

The shift value setting temperature for cooling and heating mode operation can be changed.

- 1 Select "Shift Change" from the service menu and press "OK". The shift change setting will be displayed.

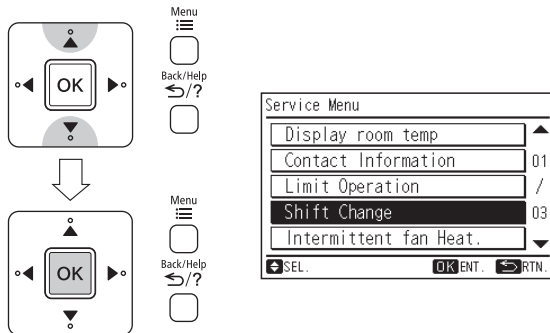

- 2 Press "△" or "▽" to select the operation mode. ("COOL" or "HEAT")

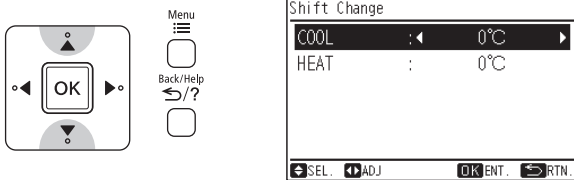

- 3 By pressing "◀" or "▶", the shift value will be changed as below.
 "...+5°C ↔ -5°C ↔ -4°C ↔ -3°C ↔ -2°C
 ↔ -1°C ↔ 0°C ↔ +1°C ↔ +2°C ↔
 +3°C ↔ +4°C ↔ +5°C ↔ -5°C (+10°F
 ↔ -10°F ↔ -8°F ↔ -6°F ↔ -4°F ↔
 -2°F ↔ 0°F ↔ +2°F ↔ +4°F ↔ +6°F
 ↔ +8°F ↔ +10°F ↔ -10°F...)"

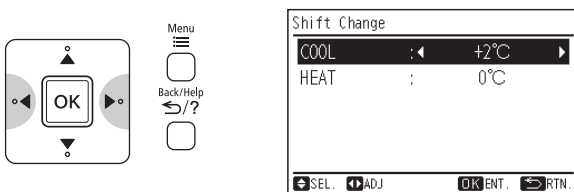

- 4 Press "OK" to finish the shift value setting. The confirmation screen will be displayed.

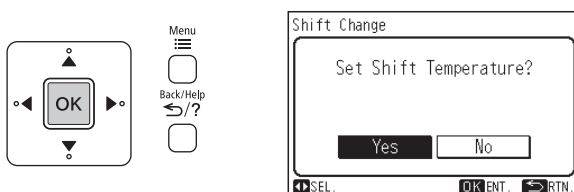

- 5 Select "Yes" by pressing "◀" or "▶" and press "OK". The setting will be confirmed and the screen will return to the service menu.

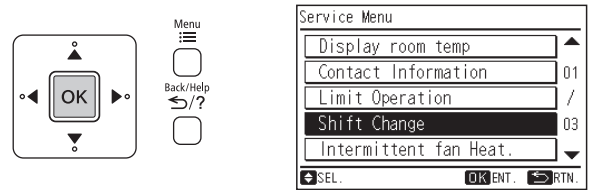

- 6 Press "Back/Help" (return/help) to return to the normal mode.

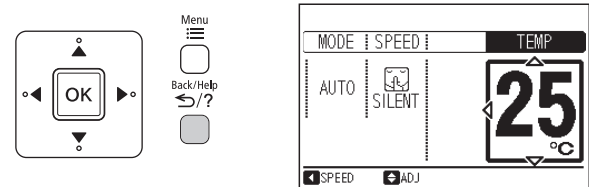

NOTE:

- When the setting is done, fan speed basically will be changed to "Silent"
- This setting cannot use during operation.
- The shift change setting will remain unchanged after the unit is turned off.
- Some indoor units are available from -3°C (-6°F) to +3°C (+6°F) only of shift change. In case of that, shift change setting of -5°C (-10°F), -4°C (-8°F), +4°C (+8°F) or +5°C (+10°F) will not be reflected to indoor unit.

10.2.1.6 INTERMITTENT FAN CONTROL

The intermittent fan control during thermo off in Heating mode mode can be changed.

- 1 Select "Intermittent fan Heat." from the service menu and press "OK".
The intermittent fan control setting will be displayed.

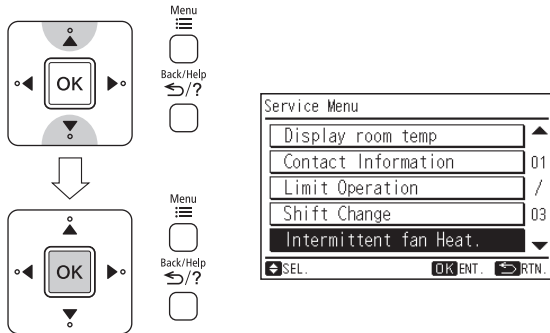

- 2 By pressing "<" or ">", the "Control Type" will be changed as below.
"... No.1 ↔ No.2 ↔ No.3 ↔ No.1 ..."

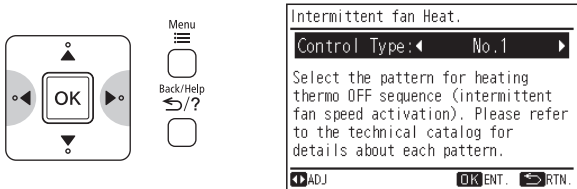

- 4 Select "Yes" by pressing "<" or ">" and press "OK".
The setting will be confirmed and the screen will return to the service menu.

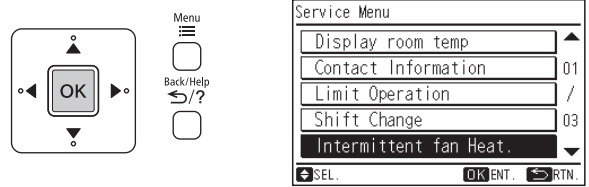

- 5 Press "Back/Help" (return/help) to return to the normal mode.

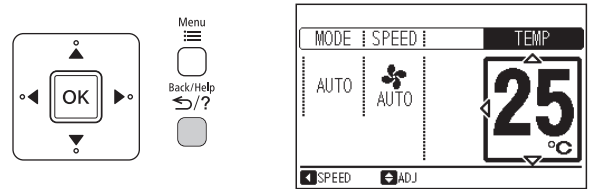

NOTE:

- This setting cannot use during operation.
- The intermittent fan control setting will remain unchanged after the unit is turned off.

	Single model	Multi model
No. 1	Continuous	30 sec ON/210 sec OFF repeatedly
No. 2	30 sec ON/210 sec OFF repeatedly	50 sec ON/190 sec OFF repeatedly
No. 3	50 sec ON/190 sec OFF repeatedly	Continuous

- 3 Press "OK" to finish the intermittent fan control setting. The confirmation screen will be displayed.

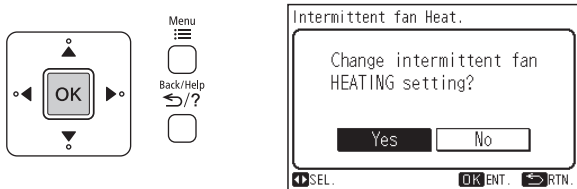

10.2.1.7 FAN SPEED DURING THERMO OFF

The fan speed during thermo off in Cooling mode can be changed.

- 1 Select "Thermo off fan Cool." from the service menu and press "OK".
The fan speed during thermo off setting will be displayed.

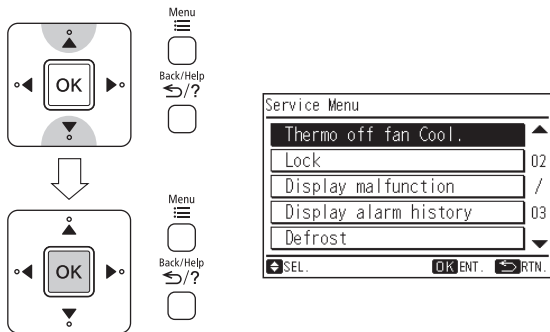

- 2 By pressing "<" or ">", the "Control Type" will be changed as below.

"Default" ↔ "Changed"

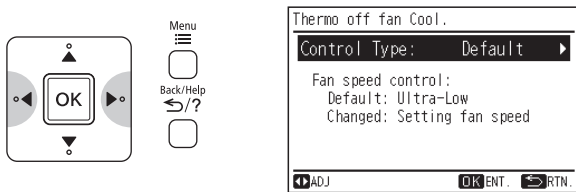

	Fan speed during thermo off
Default	Ultra low
Changed	Set fan speed (When auto fan is set, the fan speed is low.)

- 3 Press "OK" to finish the thermo off fan control setting. The confirmation screen will be displayed.

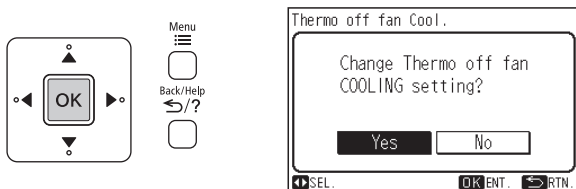

- 4 Select "Yes" by pressing "<" or ">" and press "OK".
The setting will be confirmed and the screen will return to the service menu.

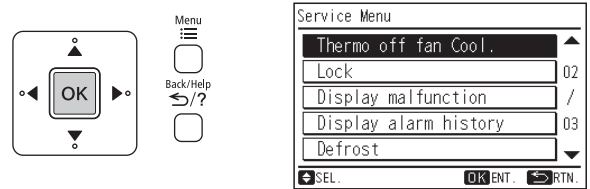

- 5 Press "Back/Help" (return/help) to return to the normal mode.

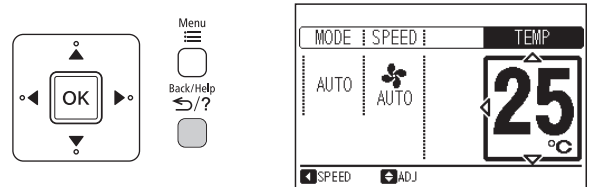

NOTE:

- This setting cannot use during operation.
- The fan speed during thermo off setting will remain unchanged after the unit is turned off.

10.2.1.8 OPERATION LOCK

This function is used to lock the operation mode from the remote controller.

The remote controller can be set to fix the "Heating" mode (including "Fan"), "Cooling" mode and "Dehumidifying" mode (including "Fan") operations.

- When unit is OFF, select "Lock" from the service menu and press "OK".
The screen of "Mode Lock" selection will be displayed.

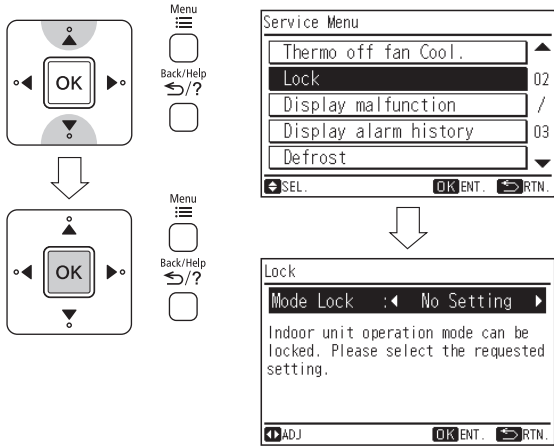

- Select "Yes" by pressing "<" or ">" and press "OK".
The setting will be confirmed and the screen will return to the service menu.

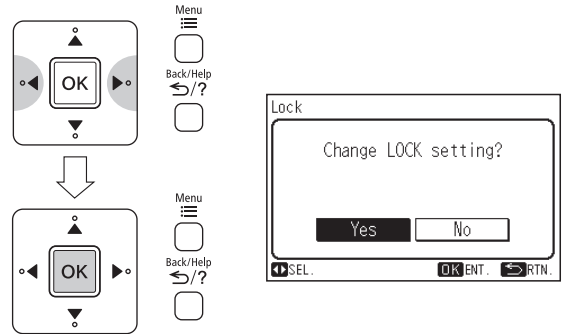

- By repeatedly pressing "<" or ">", the indication is changed in order of "No Setting" ↔ "COOL" ↔ "HEAT".
Select the function target and press "OK".
The confirmation screen will be displayed.

- Press "Back/Help" (return/help) to return to the normal mode.

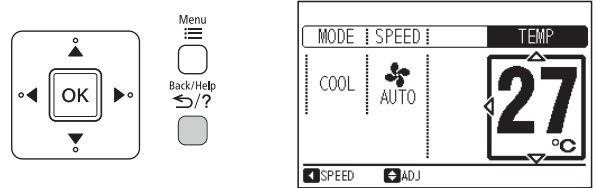

ex. Select "Cooling" mode lock

NOTE:

- The operation lock setting will remain unchanged after the unit is turned off.

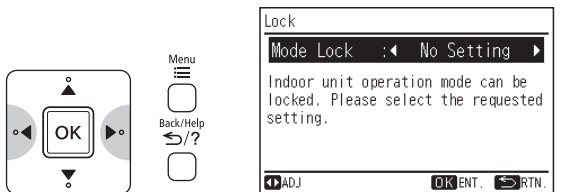

When this function is not used

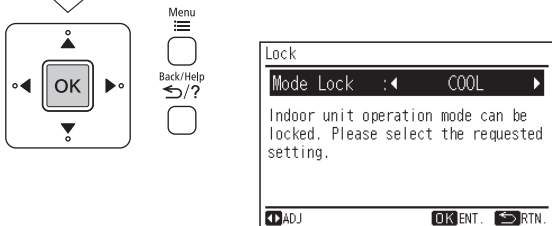

When "Cooling" mode lock is selected

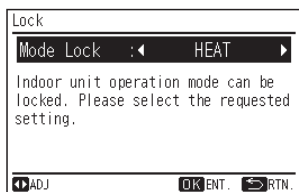

When "Heating" mode lock is selected

10.2.1.9 DISPLAY MALFUNCTION

Failure modes are stored in the nonvolatile memory of indoor unit and shall be redisplayed by this remote controller. This function is useful in checking the failure modes either during switching OFF the power or restarting the device without checking the error code on display or number of indication lamp blinking. The remote controller can redisplay up to last 5 failure modes from the memory. Thus, for some failure modes which are unable to retrieve because of remote controller limit to redisplay only 5 failure modes, it can be found by cleaning up the memory first then recheck the memory content again during the visit at the customer place.

a) How to redisplay failure diagnosis

- 1 Turn the circuit breaker OFF.
- 2 Then turn the circuit breaker ON.
- 3 To enter the service menu.
- 4 Select "Display malfunction" from the service menu and press "OK".

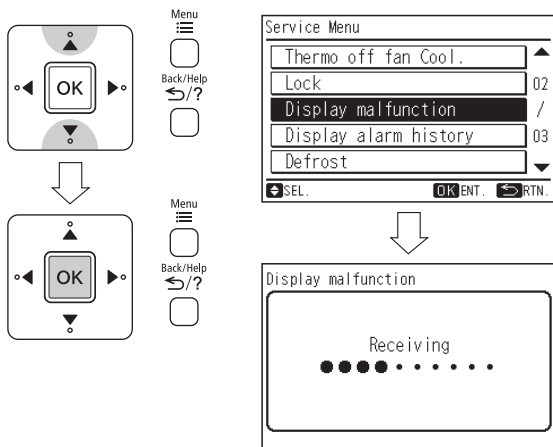

- 5 The last 5 failure modes from the memory will be displayed.

Display malfunction	
Unit	Code
Last IN	010
IN	010
IN	010
IN	009
IN	009

NOTE:

- During display, the timer lamp of indoor unit will blink at the last failure mode.

- 6 Press "Back/Help" (return/help) to return to the normal mode.

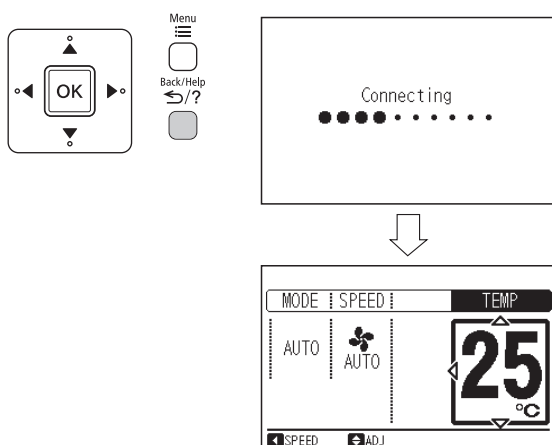

b) How to clear the failure diagnosis data

- 1 Redisplay the failure diagnosis data.
- 2 To enter the service menu.

- 3 Select "Display malfunction" from the service menu and press "OK".

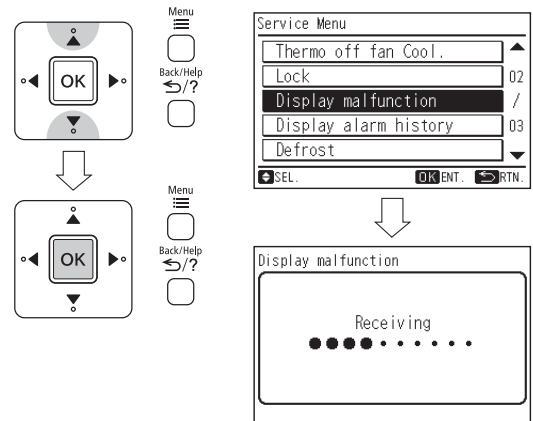

- 4 The last 5 failure modes from the memory will be displayed. "OK DeIAII" is displayed in this time.

Display malfunction	
Unit	Code
Last IN	010
IN	010
IN	010
IN	009
IN	009

Turned on

- 5 Press "OK". The confirmation screen is displayed. Select "Yes" by pressing "<" or ">" and press "OK".

When the failure diagnosis data is cleared, the screen will automatically return to the normal mode.

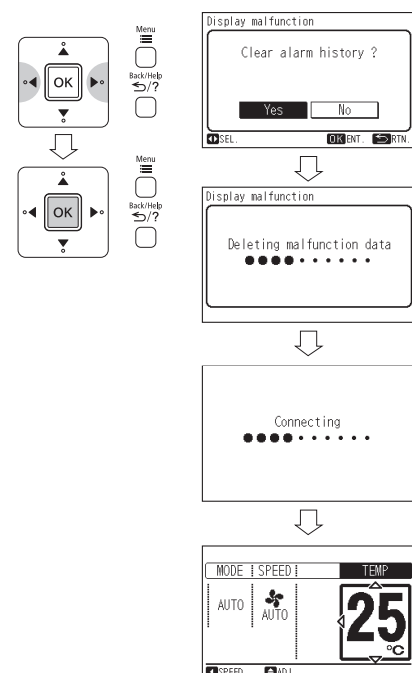

NOTE:

- The clear mode is valid only once after section "1.9.1" .

10.2.1.10 DISPLAY ALARM HISTORY

The history of failure modes are also stored in the nonvolatile memory of this remote controller. This function is useful for when a failure to check whether or not occurred. (Time and date is also indicated.) The remote controller can memorize to last 10 failure modes in the memory.

a) How to display alarm history

- 1 To enter the service menu.
- 2 Select "Display alarm history" from the service menu and press "OK".

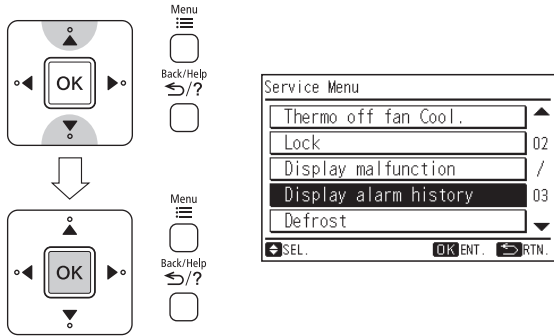

- 3 The last 10 failure modes (up to 5 failure modes per one screen) in the memory will be displayed. By pressing "△" or "▽", scroll page.

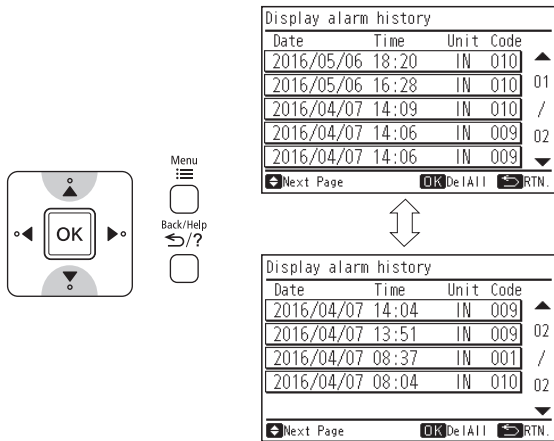

- 4 Press "Back/Help" (return/help) twice to return to the normal mode.

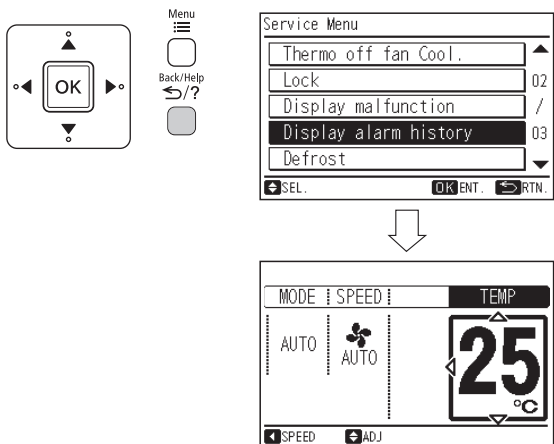

b) How to clear the alarm history

- 1 Redisplay the alarm history. (Refer to section "1.10.1")
- 2 Press "OK". The confirmation screen is displayed. Select "Yes" by pressing "◀" or "▶" and press "OK".

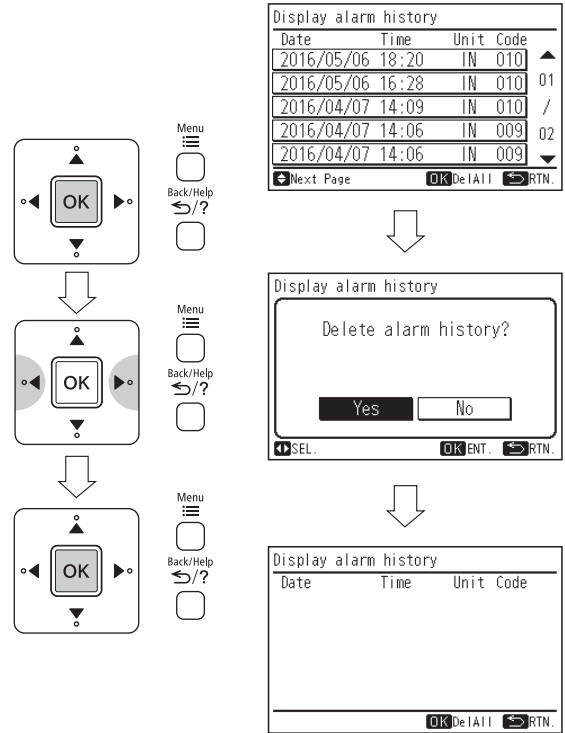

- 3 Press "Back/Help" (return/help) twice to return to the normal

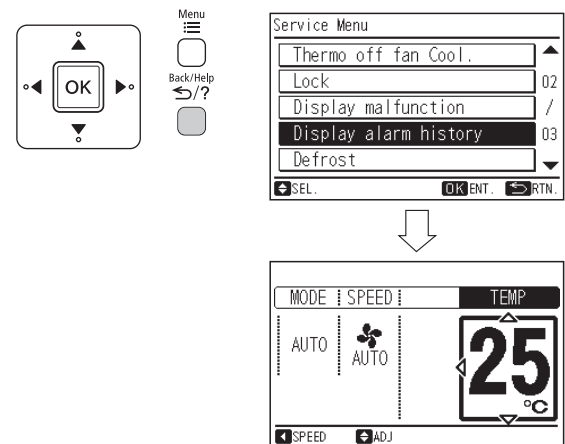

10.2.1.11 DEFROSTING INHIBIT PERIOD SELECTION

The defrosting inhibit period selection can be changed. This selection is valid with the single model only.

- 1 Turn the circuit breaker OFF.
- 2 Then turn the circuit breaker ON.
- 3 To enter the service menu.
- 4 Select "Defrost" from the service menu and press "OK".

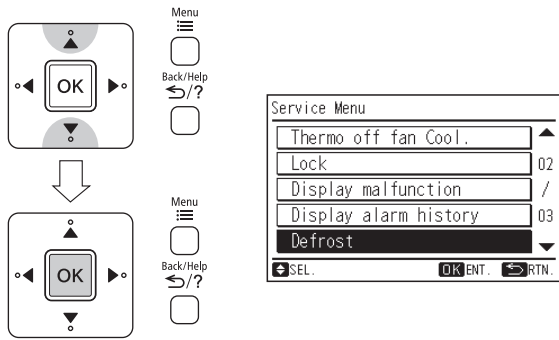

- 5 By pressing "<" or ">", the "Control Type" will be changed as below.

"Default" ↔ "Changed"

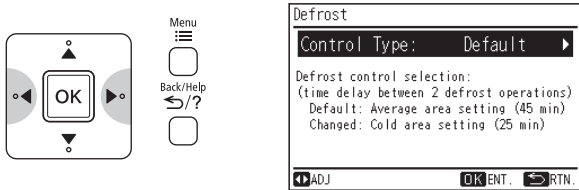

	Defrosting inhibit period
Default	Average area setting (Around 45 min)
Changed	Cold area setting (Around 25 min)

- 6 Press "OK" to finish the defrosting inhibit period selection setting. The confirmation screen will be displayed.

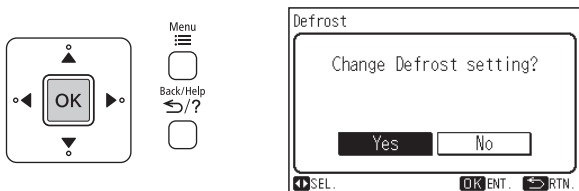

- 7 Select "Yes" by pressing "<" or ">" and press "OK". The setting will be confirmed and the screen will return to the service menu.

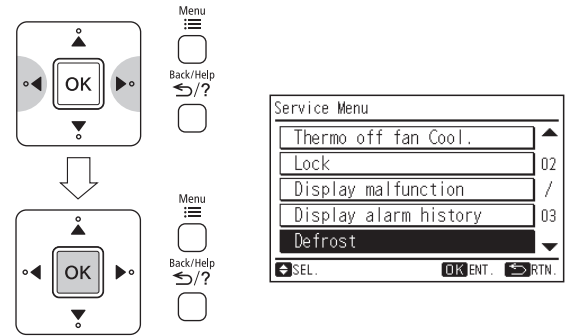

- 8 Press "Back/Help" (return/help) to return to the normal mode.

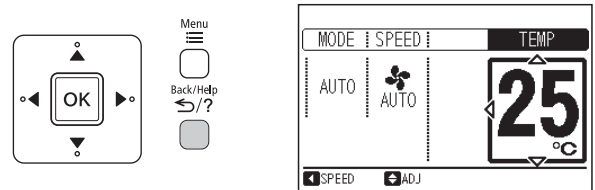

NOTE:

- The defrosting inhibit period selection setting will remain unchanged after the unit is turned off.

10.2.1.12 ECO AUTO OFF

This function is only available in the model with human detected sensor. When this function is set, the unit will be stopped automatically after set "Auto off time" when nobody is in the room at the eco mode setting.

- 1 Select "ECO AUTO OFF" from the service menu and press "OK".
The ECO AUTO OFF setting will be displayed.

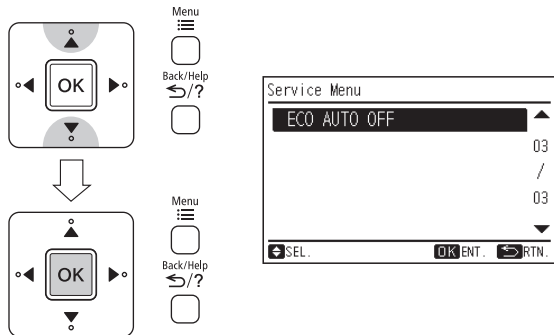

- 2 Press "△" or "▽" to select the setting items. The setting items are displayed "ECO AUTO OFF" and "Auto off time".

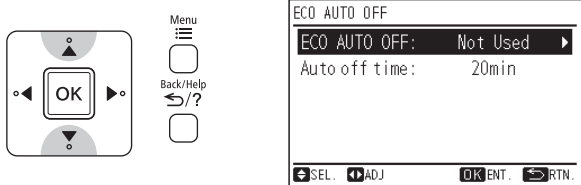

- 3 Press "◀" or "▶" to set each setting content for the selected item. When "ECO AUTO OFF" is selected, the setting contents are switched in order of "Not Used" ↔ "Used" by pressing "◀" or "▶".

When "Auto off time" is selected, the setting time can be set between "20 min" and "120 min" by pressing "◀" or "▶" cyclically. (The set unit is 10 min.)

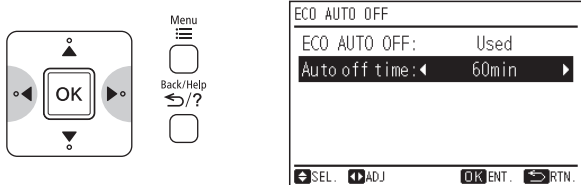

- 4 Press "OK" to finish the ECO AUTO OFF setting. The confirmation screen will be displayed.

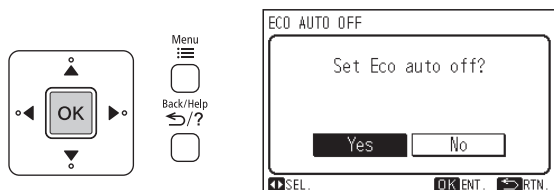

- 5 Select "Yes" by pressing "◀" or "▶" and press "OK". The screen will return to the service menu.

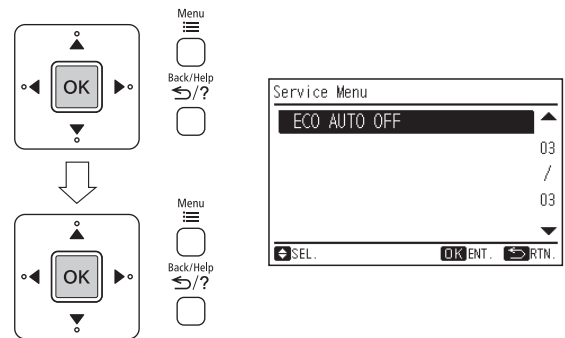

- 6 Press "Back/Help" (return/help) to return to the normal mode.

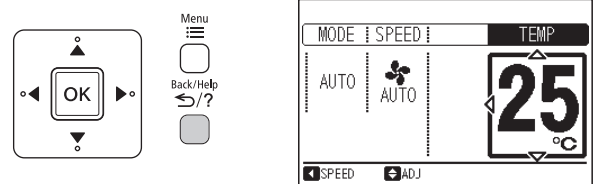

NOTE:

- The ECO AUTO OFF setting will remain unchanged after the unit is turned off.
- 7 When the ECO AUTO OFF setting is used, the screen indication will be below.

- (1) If "Eco Auto Off" setting is used, when "Eco" operation is started, "ECO" and "ECO" will be indicated on the screen of normal mode.

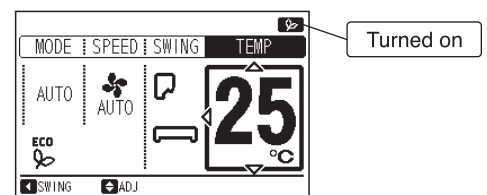

- (2) "ECO Auto Off Mode" will be indicated on the screen of normal mode when the operation is stopped by "ECO AUTO OFF" function.

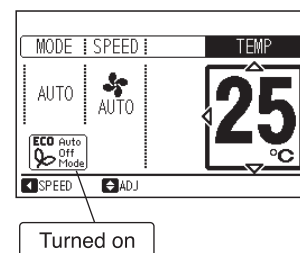

NOTE:

If the operation is stopped by "ECO AUTO OFF" function by wireless remote controller, "ECO Auto Off Mode" won't be indicated on the screen of normal mode.

10.2.1.13 CLEAN (SERVICE)

Clean(service) can be started. (i.e. FrostWash for outdoor unit)

- 1 Select "Clean(Service)" from the service menu and press "OK".
Setting item will be displayed.

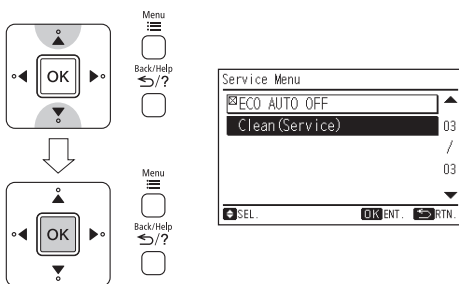

- 2 Press "△" or "▽" to select the setting items. And press "OK".
The confirmation screen will be displayed.

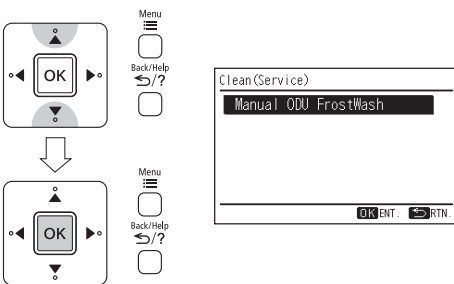

- 3 Select "Yes" by pressing "◀" or "▶" and press "OK".
The setting will be confirmed and Requesting display will be setting item will be displayed. appeared.

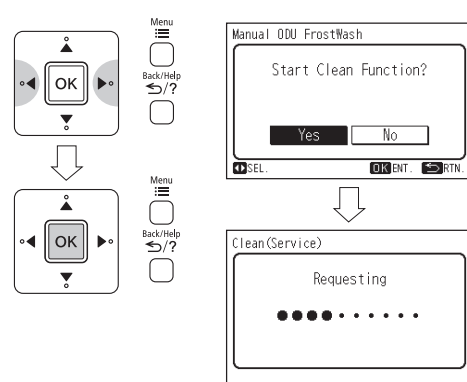

- 4 After a few seconds, Clean(service) will be started.
The running display will appear.

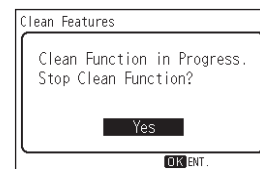

The clean operation will be stopped and the screen will be displayed the normal mode.

NOTE

- Based on the temperature condition and etc., Clean(service) might not start. In case of that, the running display will not appear. The display will return to normal mode.
- When clean operation finish, unit will stop automatically.
- If Weekly Timer or Simple Timer is set, Clean (Service) might stop at the middle point because of the timer setting.

10.2.1.14 KEY LOCK

This function is used to lock all buttons from the remote controller. When this function is set, the all buttons of remote controller will be locked.

- 1 Setting of the key lock, press "OK" and "ECO" (ECO) simultaneously for 3 seconds.
"🔒" will be indicated on the screen of normal mode, and the key lock will be set.

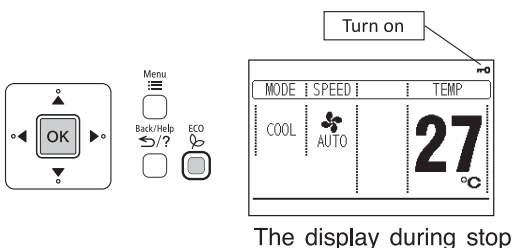

The display during stop

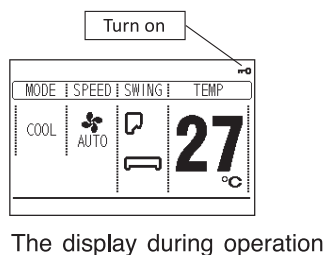

The display during operation

- 2 Cancellation of the key lock, press "OK" and "ECO" (ECO) simultaneously for 3 seconds.
"🔒" will be turned off, and the key lock will be canceled.

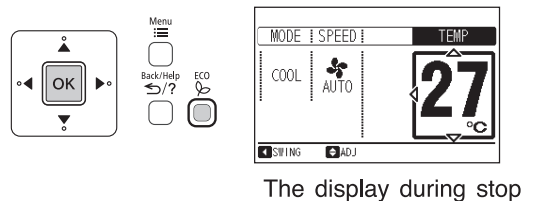

The display during stop

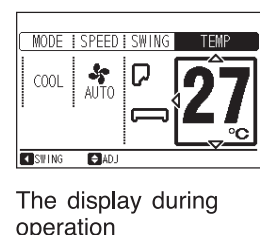

The display during operation



NOTE

- Every time pressing "OK" and "ECO" (ECO) simultaneously for 3 seconds, the key lock state will be switched alternately to locked/unlocked.





10.2.2 CHECK MENU OPERATION

10.2.2.1 SELF CHECKING

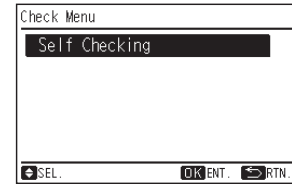
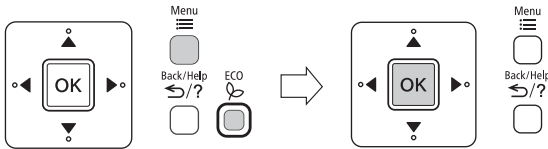
Self checking of PCB using this remote controller. The self checking performs to check the remote controller button and to clear EEPROM.

- (1) Press and hold  and  simultaneously for at least 3 seconds during the normal mode. The check menu will be displayed. Select "Self Checking" from the check menu and press "OK".



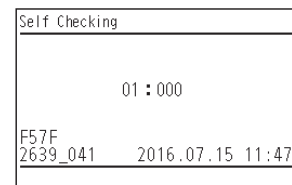

- (2) Select the process for "Self Checking".
- * To start self check, press "  ".
 - * To clear EEPROM, press "  " and "  " and "  " simultaneously. (see EEPROM clear process (14).)

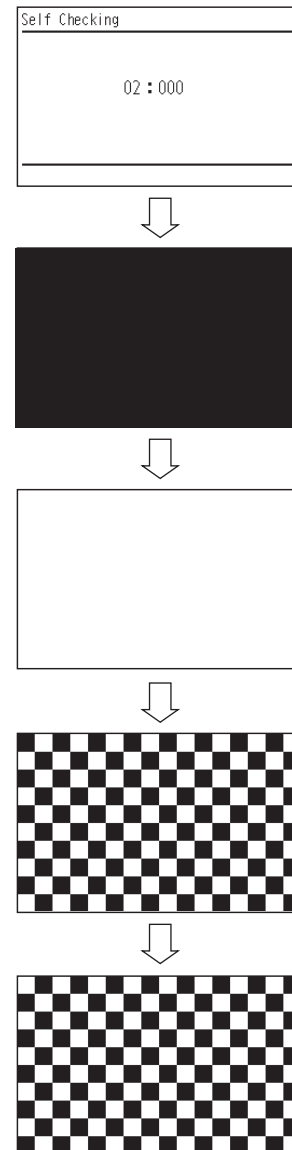

- (3) LCD test
Press "OK" and the screen will be switched as shown in the picture.

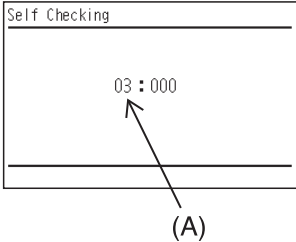
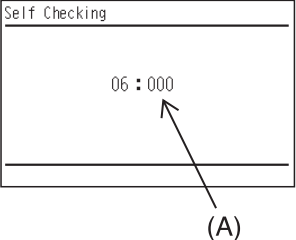

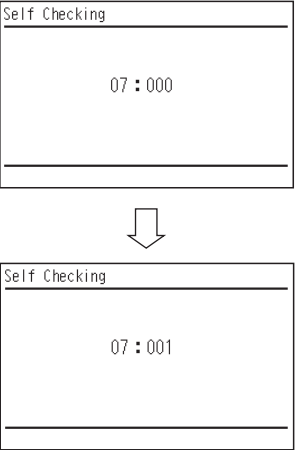
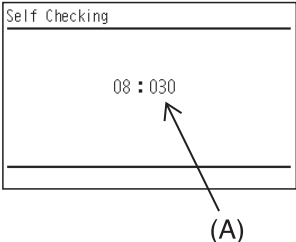
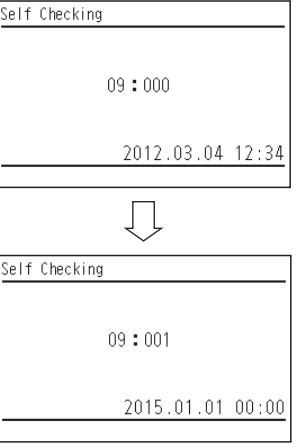
<p>(4) Back light test LCD brightness is changed gradually by pressing "OK"</p>	<p>(A) : 03 : Back light test 04 : Contrast test 05 : Operation indicator test</p>
<p>(5) Contrast test Contrast of the LCD gradually changes by pressing "OK"</p>	
<p>(6) Operation indicator test Press "OK" and the operation indicator will flash in red and green twice for each.</p>	
<p>(7) Switch input test Press the 9 switched one by one. The number indicated with "(A)" will count up as switch being pressed. * The order of pressing switch is at random. Do not press more than 1(one) button for it will not be counted.</p>	
<p>(8) Transmission circuit test The remote controller automatically starts to check the transmission circuit. * To proceed next step, press "  ".</p>	
<p>(9) Remote controller thermistor test The detected temperature by remote controller thermistor is displayed at "(A)" in the right picture.</p>	
<p>(10) Date/Time test The date and time is switched from "2012.03.04 12:34" to "2015.01.01 00:00".</p>	

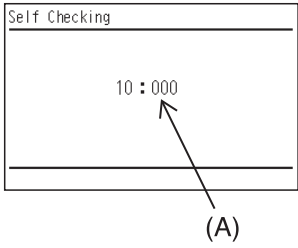
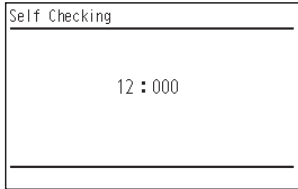
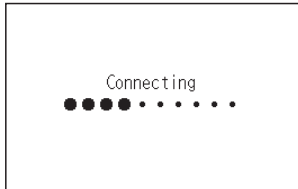
<p>(11) EEPROM test <EEPROM Clearing Cancel> Press " ^{ECO} ". <EEPROM Clear> Press " OK" or wait 15 seconds. EEPROM data will be cleared. During the process , the numbers will be indicated on where is located with "(A)". If "(A)" has value of "999", EEPROM is in faulty condition. * In case "(A)" has "999", the process does not proceed to next step.</p>	
<p>(12) Watchdog Timer test The remote controller will automatically start to check the watchdog timer. After 10 seconds are passed, the self checking is completed and the remote controller is automatically restarted. If does not restart, this check is in faulty condition.</p>	
<p>(13) When the self checking is completed, the remote controller is automatically restarted. In this case, "Connecting" is indicated and operation indicator will flash in red. So please turn the circuit breaker OFF and ON.</p>	

EEPROM process

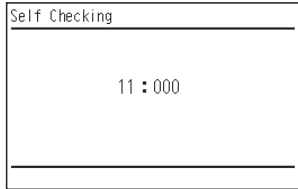
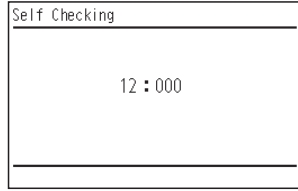
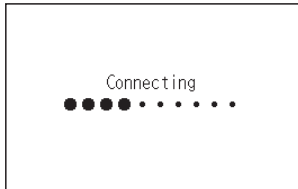
<p>(14) Clear EEPROM The remote controller will automatically restart EEPROM clearing process.</p>	
<p>(15) Watchdog Timer test The remote controller will automatically start to check the watchdog timer. After 10 seconds are passed, the self checking is completed and the remote controller is automatically restarted. If does not restart, this check is in faulty condition.</p>	
<p>(16) When the process is completed, the remote controller is automatically restarted. In this case, "Connecting" is indicated and operation indicator will flash in red. So please turn the circuit breaker OFF and ON.</p>	

10.3 H-LINK ADAPTOR – PSC 6RAD

10.3.1 SAFETY SUMMARY

DANGER:

- DO NOT pour water into the remote control switch (hereafter called “controller”). This product is equipped with electrical parts. This will cause serious electrical shock.

WARNING:

- DO NOT perform installation work and electrical wiring connection by yourself. Contact your distributor or dealer of HITACHI and ask then for installation work and electrical wiring by service person. The specified cable should be used to connect (i) room air conditioner and adaptor, and (ii) controller and adaptor.



CAUTION:



- DO NOT install the indoor unit, outdoor unit, controller and cable as such places as:
 - where there is oil vapor and dispersion of oil
 - where there is sulfuric environment (near the hot springs)
 - where there is a flammable gas
 - where there is salty environment (near the sea)
- DO NOT install the indoor unit, outdoor unit, controller and cable within approximately 3 meters from strong electromagnetic wave radiators, such as medical equipment. In case that the controller is installed in a place where there is electromagnetic wave direct-radiation, shield the controller and cables by covering with the steel box and running the cable through the metal conduit tube.
- In case that there is electric noise at the power source for the indoor unit, provide a noise filter.

10.3.2 INSTALLATION WORK

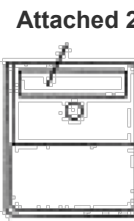
■ Before installation

Check the contents and the number of the accessories in the packing.

Adaptor	 With two 1.8m cables
1 piece of cover for hiding the covering	 Attached 2 sided tapes
Two-sided tape for attaching to Adaptor	 110x40x3mm

2 connectors for H-Link connection		
2 tapping screws for attaching to wall		φ3.0 x 10mm
2 screws for attaching to wooden wall		φ3.1 x 16mm

- 1) RAC adaptor can be installed to the wall as well as on the air conditioner itself
- 2) Install RAC adaptor in the vertical surface as shown below.

Upper side



Mark “↑ UP”

Wiring outlet

Bottom side

- 3) Installation procedure
 - a) When installing to the wall.
 - i) Fix the adaptor with 2 screws. Tapping screw is for metal surface, and other screw is for wooden surface.

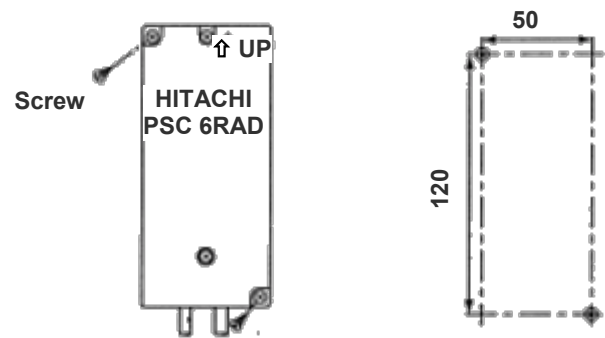

- ii) When using the cover
It can be installed at the right and left side of room air conditioner. Fix the cover and RAC adaptor with the two-sided tape (accessory).

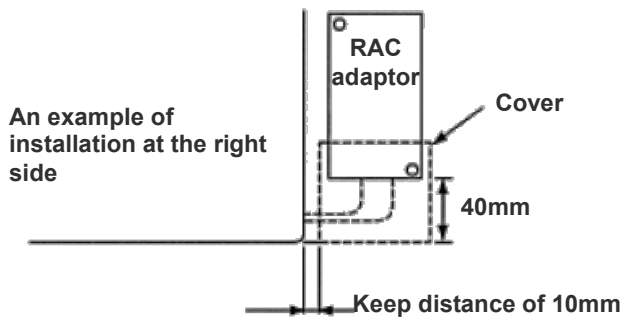

- b) When installing on the room air-conditioner
- In case that it cannot be installed to the wall due to the space or material problem, install the RAC adaptor with the two-sided tape (accessory) on the room air-conditioner.
- Confirm if the piping cover of the unit can be removed when performing the service maintenance, and then fix the RAC adaptor in the side of room air-conditioner with two-sided tape. (Available at the right as well as left side)
 - Clean the surface to be installed with a dry cloth.

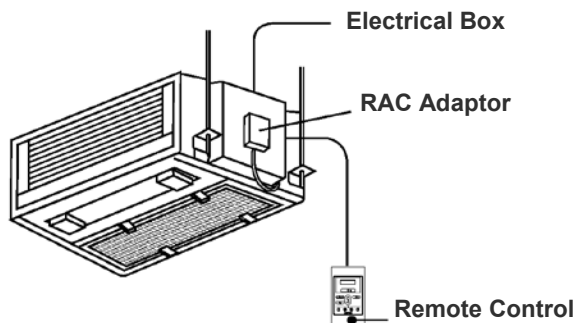
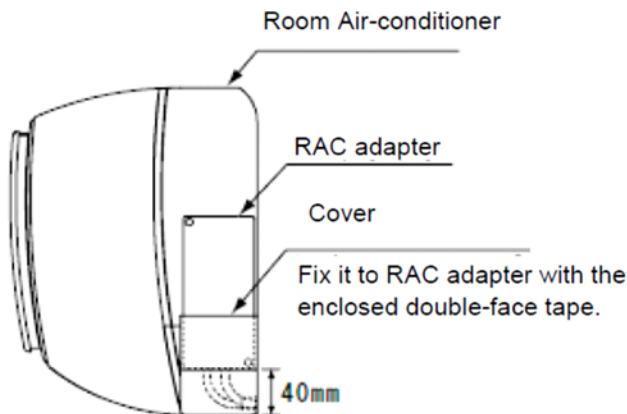
**NOTE:**

- Consider the following points since the adhesiveness changes according to the environmental conditions (temperature, humidity etc)
- The adhesiveness is decreased when there is humidity or oil.
- Warm the adhesive part and installation place of the two-sided tape to avoid the decrease of the adhesiveness in case the ambient temperature is low.
- DO NOT touch the adhesive part by fingers nor re-attach it many times. The adhesiveness has decreased and the RAC adaptor may fall off.
- DO NOT apply any force within 24 hours after installation.

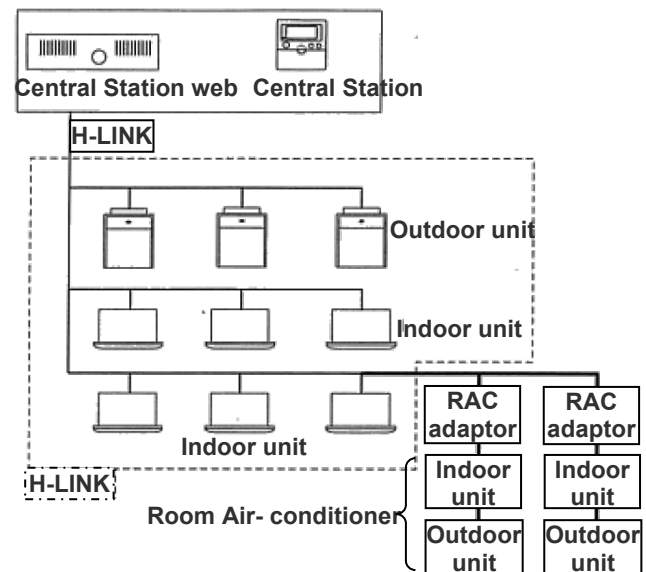
10.3.3 ELECTRICAL WIRING**■ System configuration****CAUTION:**

- Turn OFF the power supply of the room air-conditioner of the central control device when performing the wiring work
- DO NOT run all the H-LINK cable or power supply cable along the other signal cable, or malfunction may occur due to the noise, etc. If it is required to run along the other transmission cable, separate the cable more than 30cm, or run the cable through the metal tube and earth the tube.
- Follow local codes and regulations when performing electrical wiring and earth wiring.
- Transmissions cable used in H-LINK shall be 2 cores cable (0.7mm² to 1.25mm² for model: VCTF, VCT, CVV, MVVX, CVVX, VVR, VVF) or 2 cores twisted pair cable (model: KPEV, KPEV-Spec). Total length of cable shall be below 1000mm.
- DO NOT use wire with more than 3 cores.

■ Internal components and Wiring connections

Check the contents and the number of the accessories in the packing.

- Access
Open the cover by removing the ① and ② screws.



- Wiring Connection
Connection with Room Air-Conditioner
 - Remove the front cover of the room air-conditioner and the cover of electrical box.
 - The cable attached with the connector of the RAC adaptor shall be connected with the connector of indoor PCB

- iii) Install the electrical box cover paying attention not to clamp the cable. Read the installation manual of each room air-conditioner for confirming how to connect and how to assemble the cable of the RAC adaptor.

CAUTION:

- Disconnect the power plug before performing this work
- Turn OFF the break power source in case the power is supplied from the outdoor unit.
- Connection of Transmission Cable
H-LINK transmission cable connecting to RAC adaptor shall be connected to H-LINK.

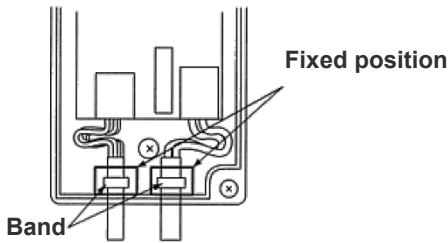
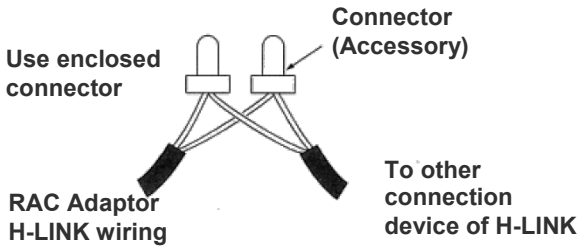

CAUTION:

- DO NOT connect incorrect wiring. It may cause the failure of the RAC Adaptor. Especially pay attention not to apply high voltage e.g. AC400/230V.
- DO NOT perform the wiring work while power to the central station or the RAC Adaptor is still being supplied. It may cause malfunction. Turn OFF devices when performing the wiring work.
- The RAC Adaptor side cable should not overload to the connector.
- DO NOT clamp the cable when attaching the RAC adaptor cover.
- Band should not be loose and in fixed position.

10.3.4 DIP SWITCH SETTING

- 1) Switch OFF the power of room air conditioner before setting the DIP switch. If the power is ON, the settings are INVALID.
- 2) The position of the DIP switch is shown below.

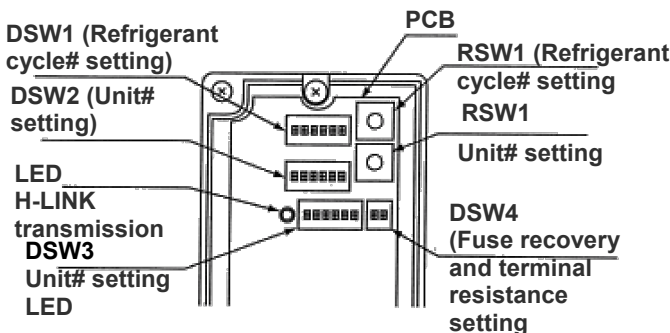

CAUTION:

- DO NOT turn ON various pins of DSW1 and DSW2

- 3) Set the refrigerant cycle# by RSW1 and DSW1

DSW1 (Ten digit)	RSW1 (Last digit)
DSW1 and RSW1 are set "0" before shipment. Up to 15 cycles can be set.	
E.g. Setting in Ref No. 5	
No. 1 pin is OFF	The position is Set 5

- 4) Set the unit No. by RSW2 and DSW2

DSW2 (Ten digit)	RSW2 (Last digit)
DSW2 and RSW3 are set "0" before shipment. Up to 15 cycles can be set.	
E.g. Setting in Unit No. 15	
No. 1 pin is OFF	The position is Set 5

- 5) Slave unit.

In case of setting various RAC adaptors in the same refrigerant cycle, set the RAC adaptor with smallest Unit# as a master unit. In case of setting only one RAC adaptor in a refrigerant system, this adaptor should be a master unit. Set this procedure by DSW3.

Master Unit setting	Setting before shipping (slave unit setting)

●: Master Unit setting

○: Setting before Shipping (Slave Unit setting)

		Indoor Unit#							
		0	1	2	3	4	5	6	7
Refrigerant Unit#	0	●	○	○	○	○			
	1			●	○	○			
	2				●	○	○	○	○
	3		●						
	4								

CAUTION:

– DO NOT set various main adaptors in the same refrigerant cycle.

- 6) Procedure when applying 200V voltage to H-LINK wiring incorrectly.

In case of applying 200V voltage to H-LINK wiring incorrectly, the fuse installed in a transmission circuit on PCB will blow out. In this case, reconnect the wiring correctly and turn ON No. 2 pin of DSW4 on PCB. The transmission circuit can be recovered. (If applying this error again, the transmission circuit can not be recovered)

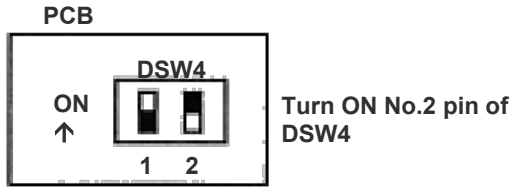

- 7) Terminating resistance is set in whole H-LINK system.
 - a) If H-LINK connecting devices like package air-conditioner are connected besides the RAC Adaptor, set the terminating resistance by those connecting devices. The terminating resistance should be set ON in only one position in whole H-LINK system.
 - b) In case that H-LINK is connected only by the RAC adaptor, set the terminating resistance by the RAC adaptor. The terminating resistance should be set ON in only one position in whole H-LINK system.

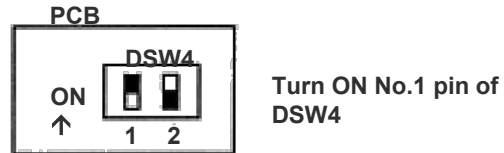

10.3.5 TEST RUN

Test run should be performed in the following after finishing the installation, wiring and setting. Refer to the installation manuals enclosed with the control system equipment.

- 1) Confirmation of RAC Adaptor Connection

Confirm if the RAC adaptor connection is recognized in the control system equipments. In case that it is not confirmed, check the transmission cable, refrigerant cycle #, indoor unit #, terminal resistance setting etc.
- 2) Registration

Confirm if the RAC adaptor connection is recognized.
- 3) Confirmation of RUN/STOP Operation.

Confirm if the room air-conditioner operate correctly by RUN/STOP from the central control system equipments. Check also if the room air-conditioner operation changes correctly by each setting.

10.4 DRY CONTACT (SPX-WDC2 AND SPX-WDC3) APPLICATION (USING DIP SWITCH)

The dry contact system enables the operation of the air conditioner indoor unit to be controlled by using external dry contacts (with non voltage) such as card-key controller or window for facilities such as hotels.

Table 1 (Applicable models and related information)

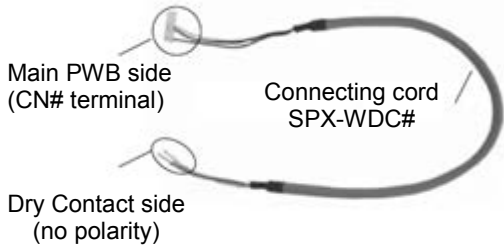
Optional Connecting cord Accessory SPX-WDC#	Model	DIP SW Label	CN#	
 <p>Main PWB side (CN# terminal)</p> <p>Connecting cord SPX-WDC#</p> <p>Dry Contact side (no polarity)</p>	SPX-WDC2	RAI-SH07/09/12QHLAE	SW501	CN5
		RAD-SH07/09/12QHLAE	SW501	CN5
	SPX-WDC3	RAS-EH07QHLAE RAS-EH09/12RHLAE RAS-SH07QHLAE RAS-SH09/12RHLAE	DSW1	CN6
		RAF-SH07/09/12QHLAE	DSW1	CN6

Note:



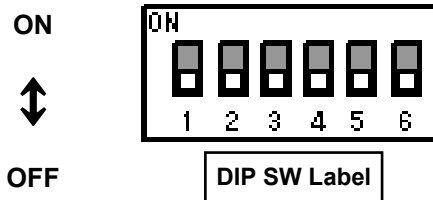

- 1) DRY CONTACT function is "Enable" by set pin No. 2 of the DIP SWITCH (refer to table 1 for the label) to ON position.
- 2) Select the proper setting for DRY CONTACT LOGIC INPUT pin No. 3 on DIP SWITCH (refer to Table 1 for the label)
 - i) Set to OFF position (Hi Input) if the type of Dry Contact switch to be used (for the CARD KEY UNIT or Window) is of contact type a (Normally Open Type) as shown in below diagram.
 - ii) Set to ON position (Lo Input) if the type of Dry contact switch to be used (for the CARD KEY UNIT or Window) is of contact type b (Normally Close Type) as shown in below diagram.



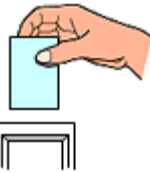
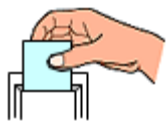

Pin No.	Function	Switch Position / Setting			
		OFF	Disable	ON	Enable
2	DRY CONTACT function	OFF	Disable	ON	Enable
3	DRY CONTACT Input Logic	OFF	HI Input Active	ON	LO Input Active

- Please decide the type of dry contact you will be using and set the position of the DIP Switch No. 2 and 3 accordingly

[1] CHECK DRY CONTACT OF CARD KEY UNIT

	AIR CONDITIONER Standby	AIR CONDITIONER Operating
CARD KEY (Door Switch)	REMOVE 	INSERT 
Contact type a	OPEN 	CLOSE 
Contact type b	CLOSE 	OPEN 

[2] SET THE POSITION OF DIP SWITCH

POSITION CONDITION OF DIP SWITCH	
INITIAL CONDITION (CARD KEY NO USE) 	No.2 : OFF No.3 : OFF
	HI Input Active No.2 : ON No.3 : OFF
	LO Input Active No.2 : ON No.3 : ON

After all connection has been done as below diagram, ON the breaker and push ON button of wireless remote controller or wired remote controller to operate the air conditioner unit.

- When the CARD KEY is in insert condition, the air conditioner operation is allowable by remote controller.
- When the dry contact switch on the Card Key Unit is open (refer to diagram below for contact type a), the unit stops to operate (it takes 10 seconds to stop the unit operation after the dry contact switch on the card key turns off) and vice versa.
- When the card key is removed from the Card Key Unit, the wireless remote controller cannot be used.
- When the card key is removed from the Card Key Unit, the wired remote controller LCD display is activated; however it has no control over the unit.
- The suitable accessory Connecting Cord (accessory code#: SPX-WDC2 or SPX-WDC3) need to be used to connect the Card Key Unit's dry contact switch to the connector on the control board of the indoor unit. Please refer to Table 1 to select suitable accessory code# for the concerning indoor model.

Example of wiring connection to Card Key Unit will be as below (reference only)

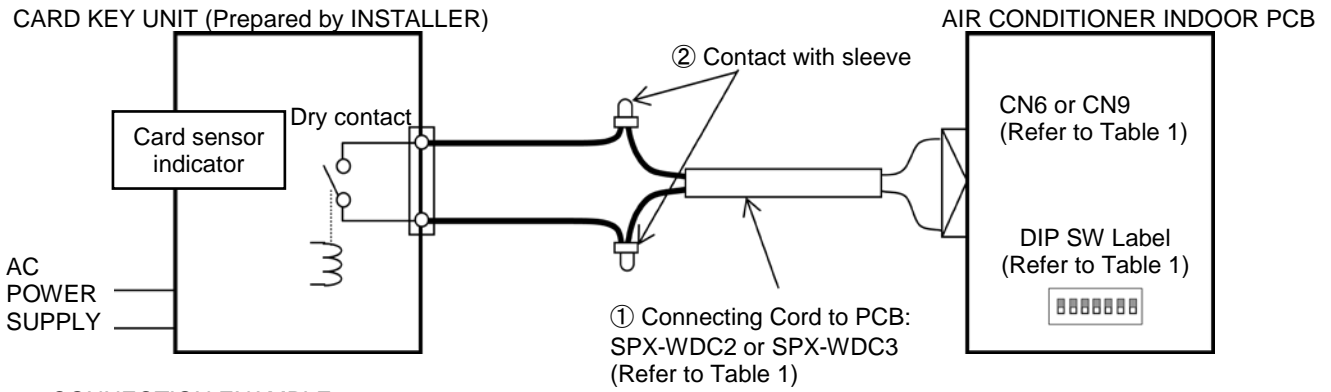

• CONNECTION EXAMPLE

i. Pin No. 3 of DIP SWITCH is set to OFF position (HI Input Active) for Dry Contact Type a

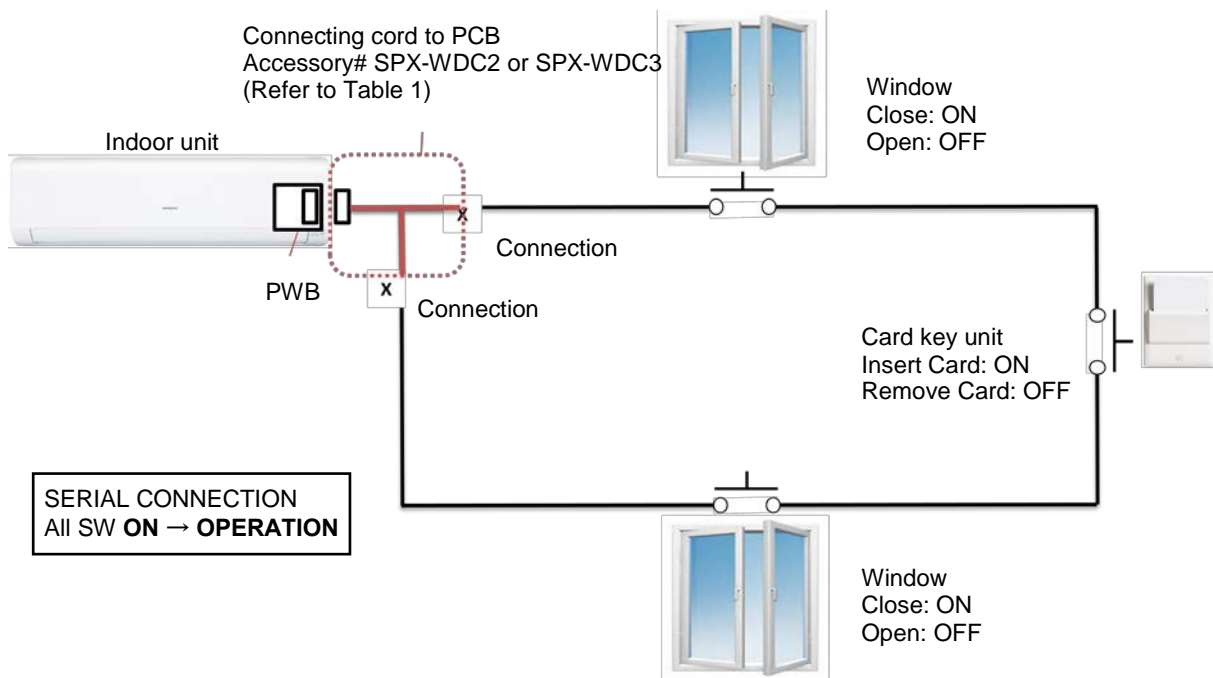

ii. Pin No. 3 of DIP SWITCH is set to ON position (LO Input Active) for Dry Contact Type b

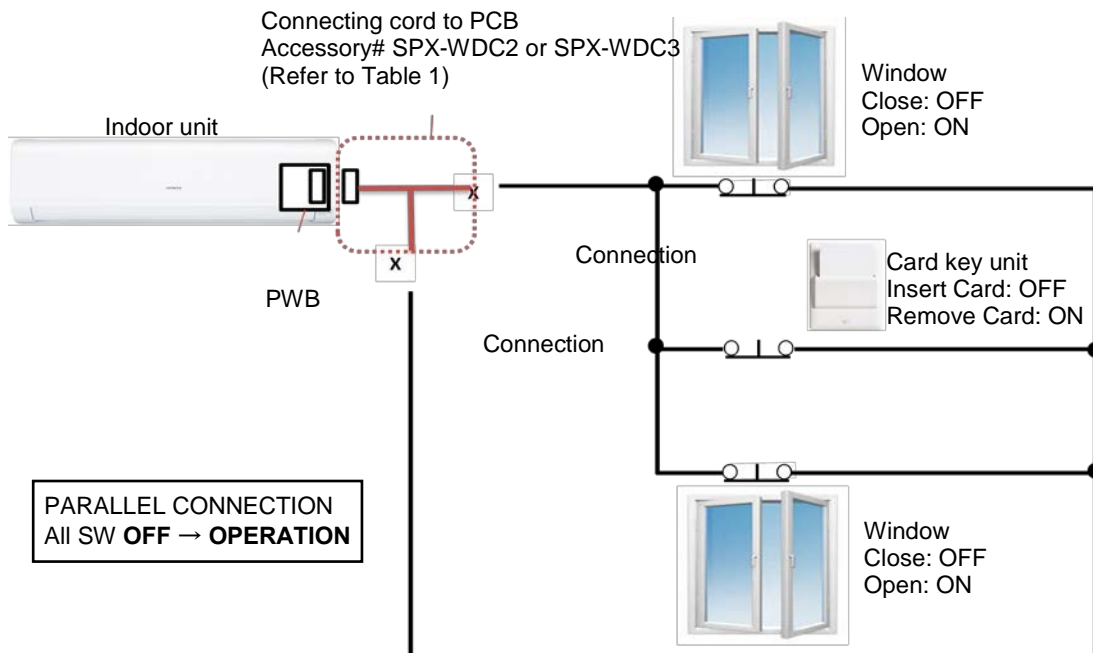

Please refer to the actual manual supplied with the optional connecting cords SPX-WDC2/WDC3 for more details.

10.5 DISTRIBUTOR – SPX-DST1

The optional distributor is to be used together with the wired remote controller when there is a need to centralize the control of multiple indoor units using only a single wired remote controller.

A single distributor could be connected further to 3 separate distributors so that up to 13 units of indoor could be controlled by a single wired remote controller.

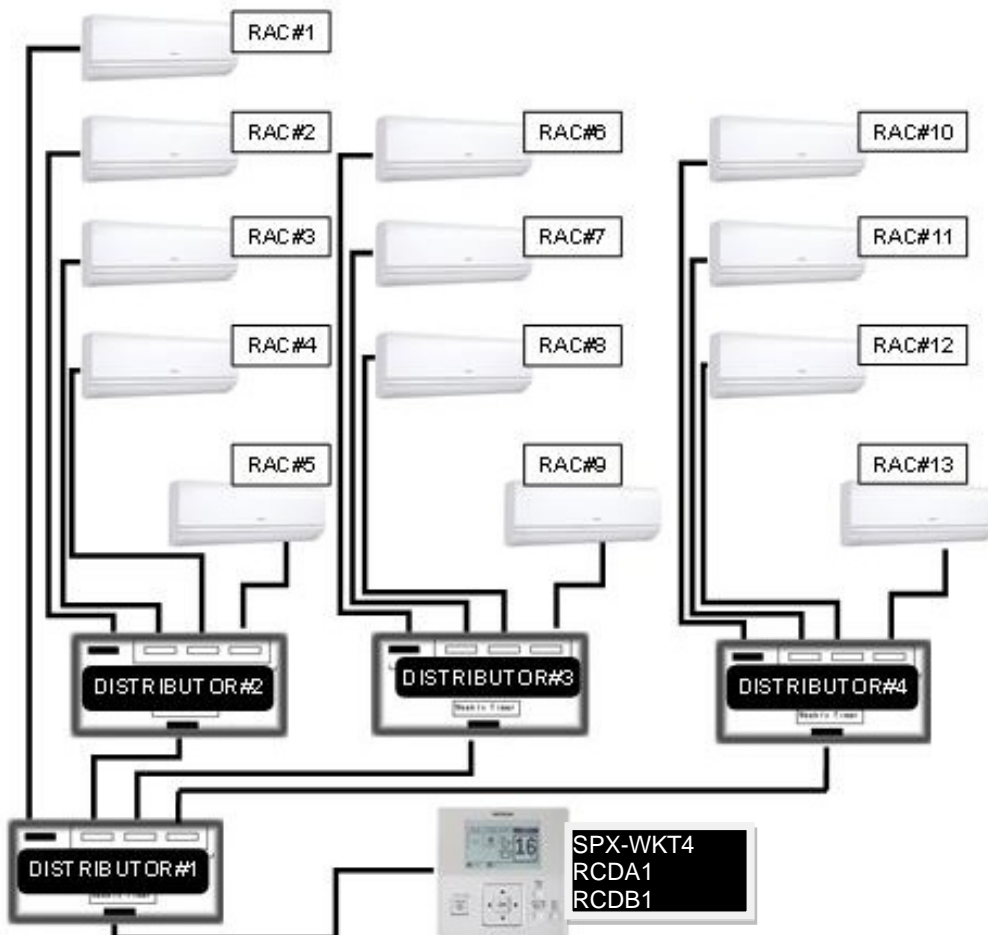
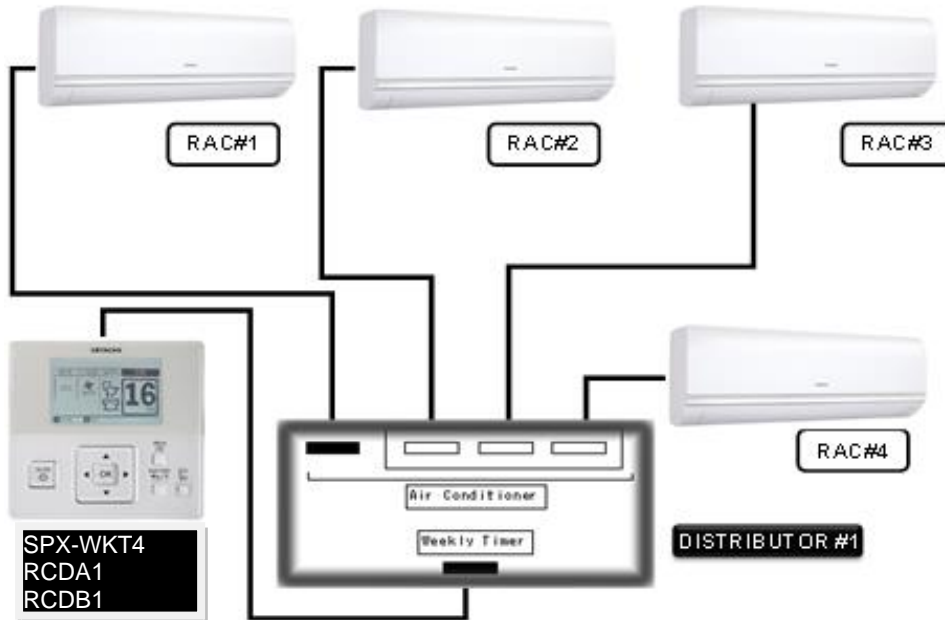

10.6 REMOTE SENSOR - SPX-RTH1

This remote sensor is applicable to Duct type indoor unit for Hitachi split system air conditioner.

10.6.1 SELECTION OF INSTALLATION POSITION

The thermistor for detecting room temperature is installed inside the remote sensor

The installation position of the remote sensor should be determined in consideration with the following conditions.

- Where the average room temperature can be detected.
- Where is not exposed to the sun
- Where the heat source is not located near the remote sensor.
- Where the discharge air from the air conditioner does not blow directly.
- Where is not affected by the outdoor air when opening / closing the door, etc

10.6.2 INSTALLATION PROCEDURE

▪ In case of mounting onto the wall (Fig.1)

- Make the wiring on the sensor box, and let the wires for sensor through the box slot.
- Fix the sensor box onto the wall with 2 screws (B)
- In case that the sensor box can not be fixed onto the wall with screws, fix it onto the wall by using the double sided adhesive tapes, etc.

▪ In case of mounting onto Electrical Switch box (Fig. 2 and 3)

- Make the holes for fixing sensor box on the Switch Box Cover (A) (field-supplied) as shown on the Fig. 3 and fix the sensor box to the plate with screws (B)
- Pay attention that the hole for air intake on the sensor box (C) may not be shut.

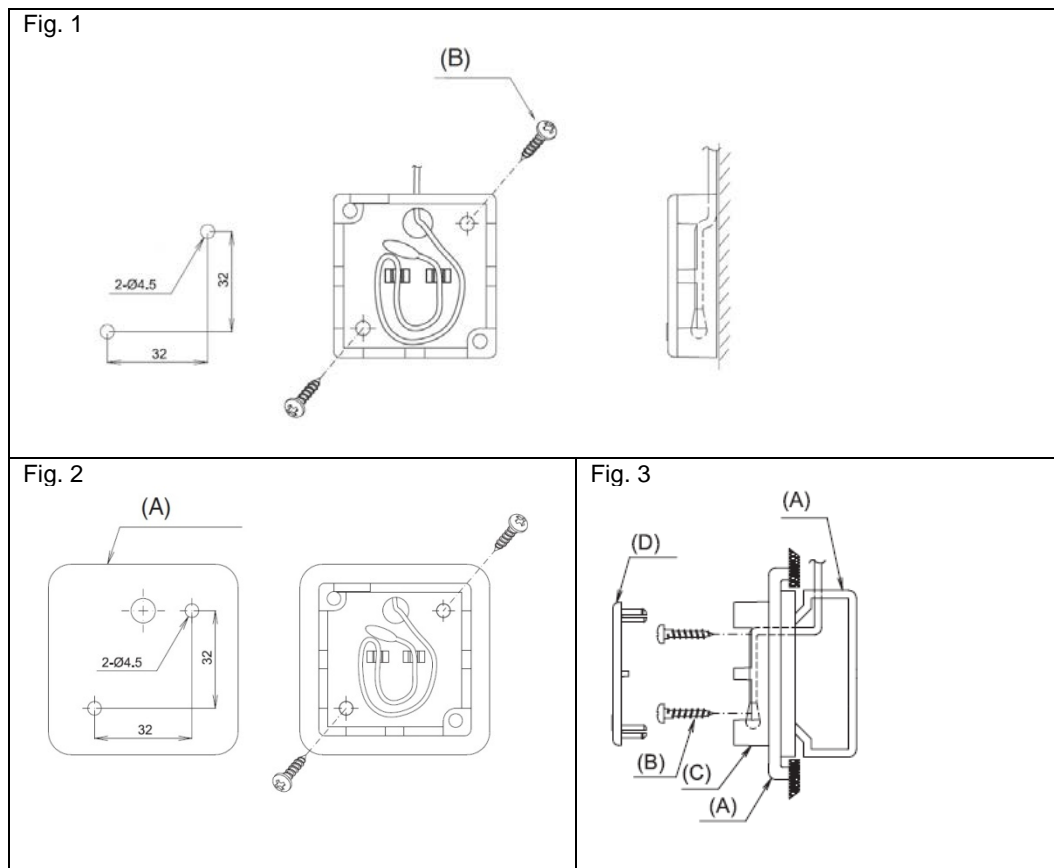

10.6.3 WIRING PROCEDURES

- Remove the original room thermistor from CN1 at the indoor printed circuit board.
- Connect the cord (15m) of the remote sensor to CN1 (Black) of the indoor printed circuit board.

Please refer to the actual manual supplied with the SPX- RTH1 for more details.

Specification in this document are subject to change without notice, in order that Johnson Controls Hitachi Air Conditioning Malaysia Sdn. Bhd. may bring the latest innovations to their customers.

Johnson Controls Hitachi Air Conditioning Malaysia Sdn. Bhd.

TC_LIT 12013835